

ANSI-Safety Relief Valve acc. to API526
Full Nozzle (ANSI 150 - 2500)

ARI-REYCO R Series
ANSI-Safety Relief Valve

- ASME Code Section VIII-Division 1.
- UV-stamp NB-stamp
- API 526

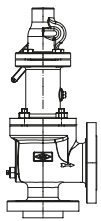
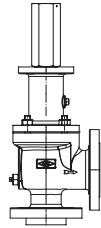
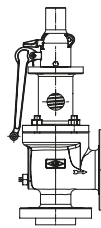

Fig. 971



973



974

Page 2

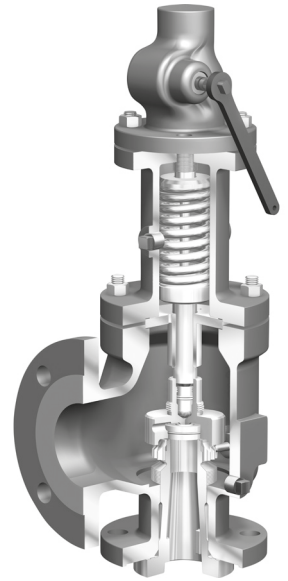

Fig. 971

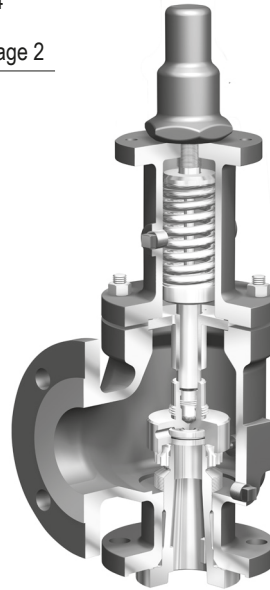

Fig. 973

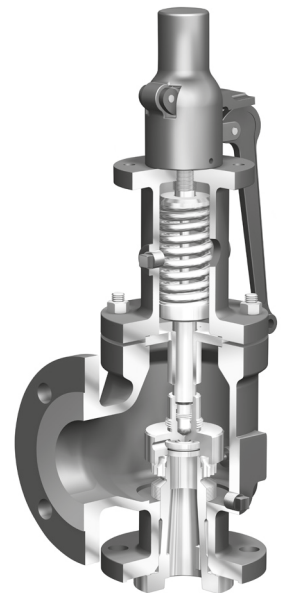

Fig. 974

Features:

- Direct loaded with spring
- Wear resistant seat/disc
- Precision disc alignment and guide
- Possible with soft seal disc
- Possible with stainless steel bellow

ARI-REYCO R Series - Safety Relief Valve (Full Nozzle) acc. to API 526

Fig. ... 971
 closed lifting device

Fig. ... 973
 gastight cap

Fig. ... 974
 open lifting device

Figure	Nominal pressure	Material	Valve size	Spring	Temperature range	Flanges
32.971 / 973 / 974	ANSI150/150	SA216WCC	1" x 2" - 8" x 10"	• Chrome vanadium • SA313Gr.316 • Inconel	-20°F to +650°F -20°F to +800°F -20°F to +800°F	ASME B16.5
35.971 / 973 / 974	ANSI300/150	SA216WCC	1" x 2" - 8" x 10"			
37.971 / 973 / 974	ANSI600/150	SA216WCC	1" x 2" - 6" x 10"			
38.971 / 973 / 974	ANSI900/(150)300	SA216WCC	1,5" x 2" - 4" x 6"			
39.971 / 973 / 974	ANSI1500/(150)300	SA216WCC	1,5" x 2" - 4" x 6"			
3c.971 / 973 / 974	ANSI2500/300	SA216WCC	1,5" x 3" - 2" x 3"			
35.971 / 973 / 974	ANSI300/150	SA217WC6	1" x 2" - 8" x 10"	• Inconel	-20°F to +1000°F	ASME B16.5
37.971 / 973 / 974	ANSI600/150	SA217WC6	1" x 2" - 6" x 10"			
38.971 / 973 / 974	ANSI900/(150)300	SA217WC6	1,5" x 2" - 4" x 6"			
39.971 / 973 / 974	ANSI1500/(150)300	SA217WC6	1,5" x 2" - 4" x 6"			
3c.971 / 973 / 974	ANSI2500/300	SA217WC6	1,5" x 3" - 2" x 3"			
52.971 / 973	ANSI150/150	SA351CF8M	1" x 2" - 8" x 10"	• SA313Gr.316 • Inconel	-400°F to +800°F -75°F to +1000°F	ASME B16.5
55.971 / 973	ANSI300/150	SA351CF8M	1" x 2" - 8" x 10"			
57.971 / 973	ANSI600/150	SA351CF8M	1" x 2" - 6" x 10"			
58.971 / 973	ANSI900/(150)300	SA351CF8M	1,5" x 2" - 4" x 6"			
59.971 / 973	ANSI1500/300	SA351CF8M	1,5" x 2" - 3" x 6"			
5c.971 / 973	ANSI2500/300	SA351CF8M	1,5" x 3" - 2" x 3"			

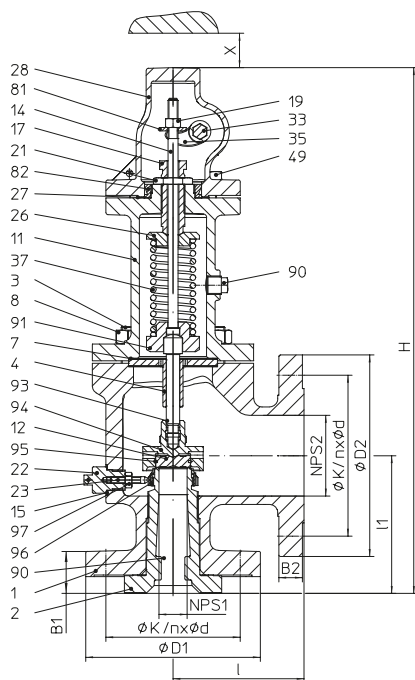
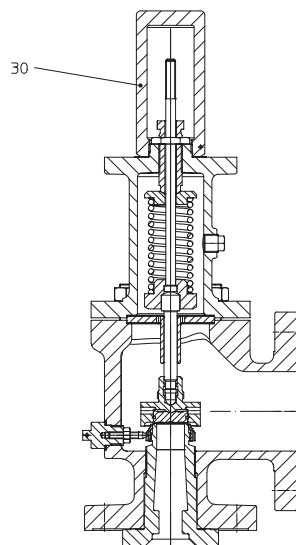
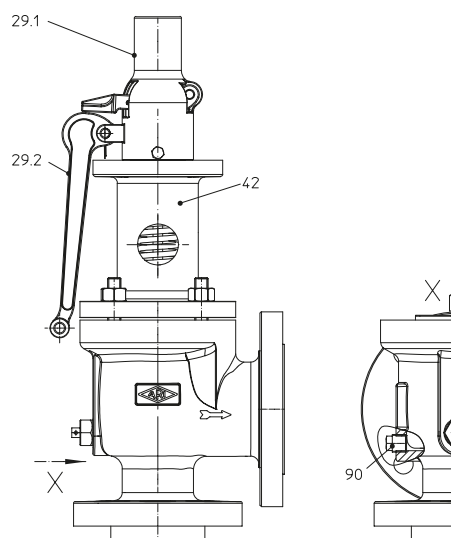
Marking

Construction / Application

Safety valve, spring loaded, direct loaded, neutral gases, vapours and liquids

Requirement
ASME Code Section VIII-Division 1.
Sizing

Calculation acc. to ASME

Details required

Medium gasform:	Mass flow (lb/h), SCFM, molar mass (kg/kmol), isotope exponent, temperature (°F), set gauge pressure (psig), back pressure (psig)
	Mass flow (kg/h), molar mass (kg/kmol), isotope exponent, temperature (°C), set gauge pressure (bar), back pressure (bar)
Medium liquid:	Volume flow (gal/min), density, viscosity, temperature (°F), set gauge pressure (psi gauge), back pressure (psig)
	Volume flow (kg/h), density (kg/m ³), viscosity, temperature (°C), set gauge pressure (bar), back pressure (bar)

Order data:

ARI-REYCO R Series - Safety Relief Valve, Figure ..., Orifice, Valve size ...x..., Class ..., Material ..., Set gauge pressure ...psig

Parts					
Pos.	Sp.p.	Description	Fig. 32.971/973/974 - 3c.971/973/974		Fig. 52.971/973 - 5c.971/973
1		Body	SA216WCC	SA217WC6	SA351CF8M
2	x	Nozzle	SA479Gr.316L (>2": SA351CF8M)		
3		Stud	SA193-B7		SA193-B8
4		Guide	SA351CF8M		
7	x	Gasket (body/bonnet)	Soft iron		Stainless steel
8		Stud nut	SA194-2H		SA194-8
11		Bonnet, closed	SA216WCC	SA217WC6	SA351CF8M
12	x	Disc	SA479Gr.316L		
14		Stem, top	SA479Gr.316L		
15	x	Gasket	Soft iron		Stainless steel
17		Compression screw	SA479Gr.316L		
19		Spindle cap	SA58Gr.303 SS		
21		Compression nut	SA479Gr.316L		
22		Locking screw (ring pin assembly)	SA479Gr.316L		
26		Top spring step	AISI1015		SA479Gr.316L
27	x	Gasket (cap)	Soft iron		Stainless steel
28		Cap, closed (Fig. 971)	SA216WCC		SA351CF8M
29.1		Cap, open (Fig. 974)	Gray iron		
29.2		Lever, open (Fig. 974)	Gray iron		
30		Cap, gastight (Fig. 973)	SA216WCC		SA351CF8M
35		Lift fork	SA216WCC		SA351CF8M
36		Lifting lever	Gray iron		
37		Spring	SA231/401, Chrome vanadium (up to 650°F)		SA313Gr.316 (up to 800°F)
			SA313Gr.316 (up to 800°F)	--	--
			Inconel X750 (up to 800°F)	Inconel X750 (up to 1000°F)	Inconel X750 (up to 1000°F)
42		Bonnet, open	SA216WCC	SA217WC6	SA351CF8M
49		Bolt	SA193-B7		
71	x	Gasket (gag screw)	Soft iron		Stainless steel
72		Gag screw	SA479Gr.316L		
74		Retaining plate	SA479Gr.316L		
75	x	O-ring	Viton		
77		Retaining screw	SA479Gr.304L		
90		Pipe plug	SA193-B7		SA193-B8
91		Bottom spring step	AISI1015		SA479Gr.316L
93		Point	SA479Gr.316L		
94		Disc holder	SA479Gr.316L (> Orifice K: SA351CF8M)		
95		Snap ring	SA313Gr.302		
96		Adjusting screw	SA351CF8M		
		L Spare parts			

Certified coefficient of discharge K	UV/NB-stamp									
	1"x2"	1 1/2"x2" 1 1/2"x2 1/2"	1 1/2"x3"	2"x3"	3"x4"	3"x6"	4"x6"	6"x8"	6"x10"	8"x10"
Steam / Gas	0,860									
Liquid	0,724									

Information / restriction of technical rules need to be observed!

A production allowance acc. to TRB 801 No. 45 exists

The engineer, designing a system or a plant, is responsible for the selection of the correct valve.

Resistance and fitness must be verified and contact the manufacturer for information (see product overview and resistance table).

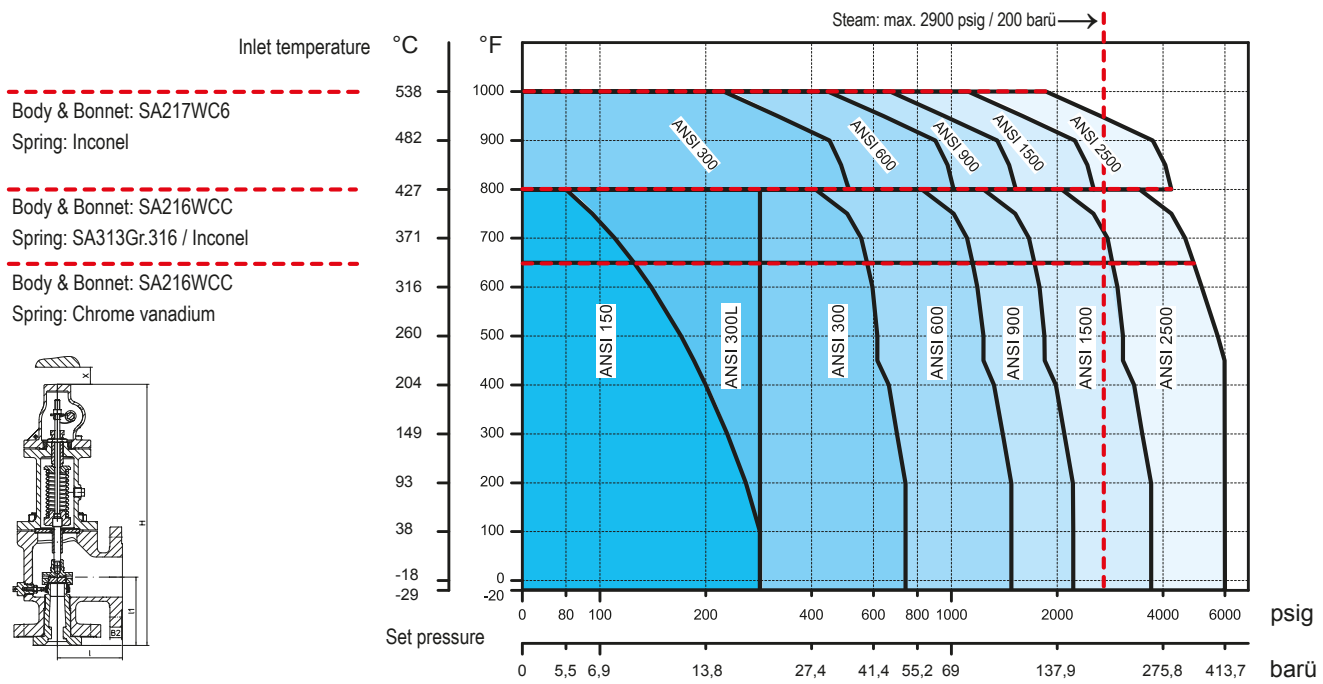
Specifications - Orifice D (effective area acc. to API: 0,110 in²)

Valve size	Material		Flangeconnection ANSI std. (RF or RTJ)		max. pressure rating limit							Dimensions				Weight	
					Inlet flange					Outlet flange	Bellows seal	I	I1	Max. H	Min. X		
					Inlet Class	Outlet Class	100°F psig	450°F psig	650°F psig	800°F psig	1000°F psig	100°F psig	100°F psig	inch	inch		inch
inch	Body & Bonnet	Spring															
1 D 2	SA216WCC	Chr. vanad.	150	150	285	185	125			285	230	4 1/2	4 1/8	20	6	40	
1 D 2	SA216WCC	SA313Gr.316	150	150		185	125	80		285	230	4 1/2	4 1/8	20	6	40	
1 D 2	SA216WCC	Inconel	150	150		185	125	80		285	230	4 1/2	4 1/8	20	6	40	
1 D 2	SA216WCC	Chr. vanad.	300L	150	285	285	285			285	230	4 1/2	4 1/8	20	6	43	
1 D 2	SA216WCC	SA313Gr.316	300L	150		285	285	285		285	230	4 1/2	4 1/8	20	6	43	
1 D 2	SA216WCC	Inconel	300L	150		285	285	285		285	230	4 1/2	4 1/8	20	6	43	
1 D 2	SA216WCC	Chr. vanad.	300	150	740	615	590			285	230	4 1/2	4 1/8	20	6	45	
1 D 2	SA216WCC	SA313Gr.316	300	150		615	590	410		285	230	4 1/2	4 1/8	20	6	45	
1 D 2	SA216WCC	Inconel	300	150		615	590	410		285	230	4 1/2	4 1/8	20	6	45	
1 D 2	SA217WC6	Inconel	300	150				510	215	285	230	4 1/2	4 1/8	20	6	45	
1 D 2	SA216WCC	Chr. vanad.	600	150	1480	1235	1175			285	230	4 1/2	4 1/8	20	6	45	
1 D 2	SA216WCC	SA313Gr.316	600	150		1235	1175	825		285	230	4 1/2	4 1/8	20	6	45	
1 D 2	SA216WCC	Inconel	600	150		1235	1175	825		285	230	4 1/2	4 1/8	20	6	45	
1 D 2	SA217WC6	Inconel	600	150				1015	430	285	230	4 1/2	4 1/8	20	6	45	
1.5 D 2	SA216WCC	Chr. vanad.	900	300	2220	1845	1765			600	500	5 1/2	4 1/8	20	8	58	
1.5 D 2	SA216WCC	SA313Gr.316	900	300		1845	1765	1235		600	500	5 1/2	4 1/8	20	8	58	
1.5 D 2	SA216WCC	Inconel	900	300		1845	1765	1235		600	500	5 1/2	4 1/8	20	8	58	
1.5 D 2	SA217WC6	Inconel	900	300				1525	650	600	500	5 1/2	4 1/8	20	8	58	
1.5 D 2	SA216WCC	Chr. vanad.	1500	300	3705	3080	2940			600	500	5 1/2	4 1/8	20	8	58	
1.5 D 2	SA216WCC	SA313Gr.316	1500	300		3080	2940	2060		600	500	5 1/2	4 1/8	20	8	58	
1.5 D 2	SA216WCC	Inconel	1500	300		3080	2940	2060		600	500	5 1/2	4 1/8	20	8	58	
1.5 D 2	SA217WC6	Inconel	1500	300				2540	1080	600	500	5 1/2	4 1/8	20	8	58	
1.5 D 3	SA216WCC	Chr. vanad.	2500	300	6000	6000	4905			740	500	7	5 1/2	22 1/2	10	80	
1.5 D 3	SA216WCC	SA313Gr.316	2500	300		6000	4905	3430		740	500	7	5 1/2	22 1/2	10	80	
1.5 D 3	SA216WCC	Inconel	2500	300		6000	4905	3430		740	500	7	5 1/2	22 1/2	10	80	
1.5 D 3	SA217WC6	Inconel	2500	300				4230	1800	740	500	7	5 1/2	22 1/2	10	80	

Center to face dimensions acc. to API 526.

Standard-flange dimensions refer to page 44.

Note

1. Valves set under 15 psig are not ASME code stamped.
2. Valve dimensions H for bellows valves add 0,75 inch. Maximum I and I1 dimensions +/- 1/16 inch
3. API526 eliminated 2 1/2 inch flange sizes, however ARI will supply 2 1/2 inch flange sizes at no additional cost
4. Outlet pressure limit for temperatures above 100°F shall not exceed the rating in ANSI/ASME B16.34

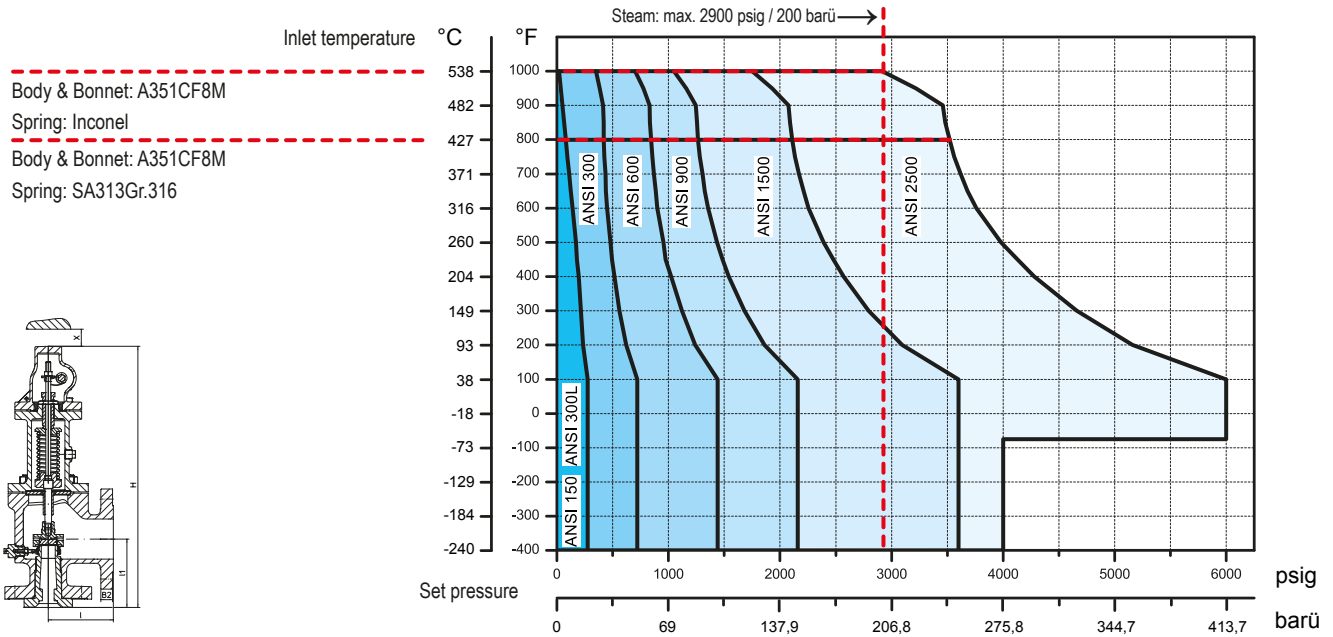

Specifications - Orifice D (effective area acc. to API: 0,110 in²)

Valve size	Material		Flangeconnection ANSI std. (RF or RTJ)		max. pressure rating limit								Dimensions				Weight			
					Inlet flange								Outlet flange	Bellows seal	I	I1		Max. H	Min. X	
					Inlet	Outlet	-400°F bis -76°F	-75°F bis -21°F	-20°F bis 100°F	450 °F	550 °F	800 °F								1000 °F
inch	Body & Bonnet	Spring	Class	Class	psig	psig	psig	psig	psig	psig	psig	psig	psig	psig	psig	inch	inch	inch	inch	lbs
1 D 2	SA351CF8M	SA313Gr.316	150	150	275	275	275	180	155			275	230	4 1/2	4 1/8	20	6	40		
1 D 2	SA351CF8M	Inconel	150	150					155	80	20	275	230	4 1/2	4 1/8	20	6	40		
1 D 2	SA351CF8M	SA313Gr.316	300L	150	275	275	275	275	275			275	230	4 1/2	4 1/8	20	6	43		
1 D 2	SA351CF8M	Inconel	300L	150					275	275	275	275	230	4 1/2	4 1/8	20	6	43		
1 D 2	SA351CF8M	SA313Gr.316	300	150	720	720	720	495	465			275	230	4 1/2	4 1/8	20	6	45		
1 D 2	SA351CF8M	Inconel	300	150					465	420	350	275	230	4 1/2	4 1/8	20	6	45		
1 D 2	SA351CF8M	SA313Gr.316	600	150	1440	1440	1440	975	928			275	230	4 1/2	4 1/8	20	6	45		
1 D 2	SA351CF8M	Inconel	600	150					928	845	700	275	230	4 1/2	4 1/8	20	6	45		
1.5 D 2	SA351CF8M	SA313Gr.316	900	300	2160	2160	2160	1485	1395			600	500	5 1/2	4 1/8	20	8	58		
1.5 D 2	SA351CF8M	Inconel	900	300					1395	1265	1050	600	500	5 1/2	4 1/8	20	8	58		
1.5 D 2	SA351CF8M	SA313Gr.316	1500	300	3600	3600	3600	2480	2323			600	500	5 1/2	4 1/8	20	8	58		
1.5 D 2	SA351CF8M	Inconel	1500	300					2323	2110	1750	600	500	5 1/2	4 1/8	20	8	58		
1.5 D 3	SA351CF8M	SA313Gr.316	2500	300	4000	6000	6000	4130	3870			720	500	7	5 1/2	22 1/2	10	80		
1.5 D 3	SA351CF8M	Inconel	2500	300					3870	3520	2915	720	500	7	5 1/2	22 1/2	10	80		

Center to face dimensions acc. to API 526. Standard-flange dimensions refer to page 44.

Note

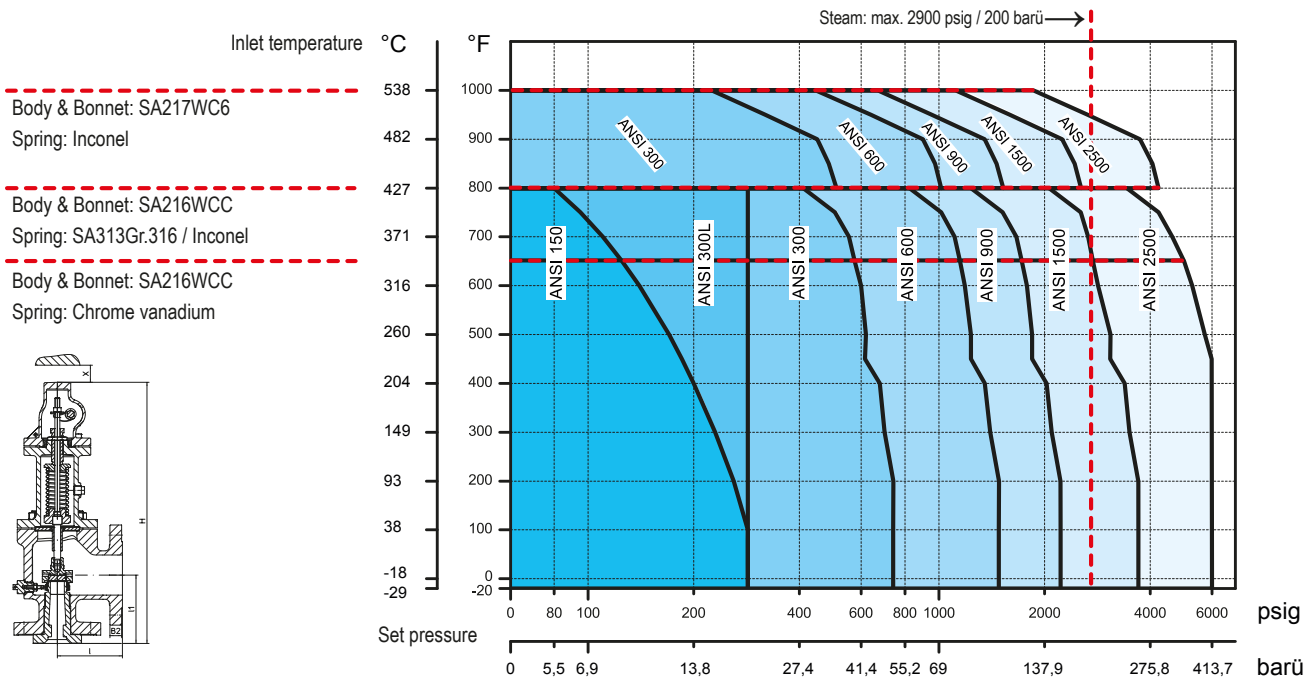
- Valves set under 15 psig are not ASME code stamped.
- Valve dimensions H for bellows valves add 3/4-inch. Maximum I and I1 dimensions +/- 1/16-inch
- API526 eliminated 2 1/2-inch flange sizes, however ARI will supply 2 1/2-inch flange sizes at no additional cost.
- Outlet pressure limit for temperatures above 100°F shall not exceed the rating in ANSI/ASME B16.34



Specifications - Orifice E (effective area acc. to API: 0,196 in²)

Valve size	Material		Flangeconnection (ANSI std. (RF or RTJ))		max. pressure rating limit							Dimensions				Weight	
					Inlet flange					Outlet flange	Bellows seal	I	I1	Max. H	Min. X		
					100°F	450°F	650°F	800°F	1000°F	100°F	100°F	inch	inch	inch	inch		
inch	Body & Bonnet	Spring	Inlet Class	Outlet Class	psig	psig	psig	psig	psig	psig	psig	psig	inch	inch	inch	inch	lbs
1 E 2	SA216WCC	Chr. vanad.	150	150	285	185	125				285	230	4 1/2	4 1/8	20	6	40
1 E 2	SA216WCC	SA313Gr.316	150	150		185	125	80			285	230	4 1/2	4 1/8	20	6	40
1 E 2	SA216WCC	Inconel	150	150		185	125	80			285	230	4 1/2	4 1/8	20	6	40
1 E 2	SA216WCC	Chr. vanad.	300L	150	285	285					285	230	4 1/2	4 1/8	20	6	43
1 E 2	SA216WCC	SA313Gr.316	300L	150		285	285	285			285	230	4 1/2	4 1/8	20	6	43
1 E 2	SA216WCC	Inconel	300L	150		285	285	285			285	230	4 1/2	4 1/8	20	6	43
1 E 2	SA216WCC	Chr. vanad.	300	150	740	615	590				285	230	4 1/2	4 1/8	20	6	45
1 E 2	SA216WCC	SA313Gr.316	300	150		615	590	410			285	230	4 1/2	4 1/8	20	6	45
1 E 2	SA216WCC	Inconel	300	150		615	590	410			285	230	4 1/2	4 1/8	20	6	45
1 E 2	SA217WC6	Inconel	300	150				510	215		285	230	4 1/2	4 1/8	20	6	45
1 E 2	SA216WCC	Chr. vanad.	600	150	1480	1235	1175				285	230	4 1/2	4 1/8	20	6	45
1 E 2	SA216WCC	SA313Gr.316	600	150		1235	1175	825			285	230	4 1/2	4 1/8	20	6	45
1 E 2	SA216WCC	Inconel	600	150		1235	1175	825			285	230	4 1/2	4 1/8	20	6	45
1 E 2	SA217WC6	Inconel	600	150				1015	430		285	230	4 1/2	4 1/8	20	6	45
1.5 E 2	SA216WCC	Chr. vanad.	900	300	2220	1845	1765				600	500	5 1/2	4 1/8	20	8	58
1.5 E 2	SA216WCC	SA313Gr.316	900	300		1845	1765	1235			600	500	5 1/2	4 1/8	20	8	58
1.5 E 2	SA216WCC	Inconel	900	300		1845	1765	1235			600	500	5 1/2	4 1/8	20	8	58
1.5 E 2	SA217WC6	Inconel	900	300				1525	650		600	500	5 1/2	4 1/8	20	8	58
1.5 E 2	SA216WCC	Chr. vanad.	1500	300	3705	3080	2940				600	500	5 1/2	4 1/8	20	8	58
1.5 E 2	SA216WCC	SA313Gr.316	1500	300		3080	2940	2060			600	500	5 1/2	4 1/8	20	8	58
1.5 E 2	SA216WCC	Inconel	1500	300		3080	2940	2060			600	500	5 1/2	4 1/8	20	8	58
1.5 E 2	SA217WC6	Inconel	1500	300				2540	1080		600	500	5 1/2	4 1/8	20	8	58
1.5 E 3	SA216WCC	Chr. vanad.	2500	300	6000	6000	4905				740	500	7	5 1/2	22 1/2	10	80
1.5 E 3	SA216WCC	SA313Gr.316	2500	300		6000	4905	3430			740	500	7	5 1/2	22 1/2	10	80
1.5 E 3	SA216WCC	Inconel	2500	300		6000	4905	3430			740	500	7	5 1/2	22 1/2	10	80
1.5 E 3	SA217WC6	Inconel	2500	300				4230	1800		740	500	7	5 1/2	22 1/2	10	80

Center to face dimensions acc. to API 526.

Standard-flange dimensions refer to page 44.

Note

1. Valves set under 15 psig are not ASME code stamped.
2. Valve dimensions H for bellows valves add 3/4-inch. Maximum I and I1 dimensions +/- 1/16-inch
3. API526 eliminated 2 1/2-inch flange sizes, however ARI will supply 2 1/2-inch flange sizes at no additional cost.
4. Outlet pressure limit for temperatures above 100°F shall not exceed the rating in ANSI/ASME B16.34

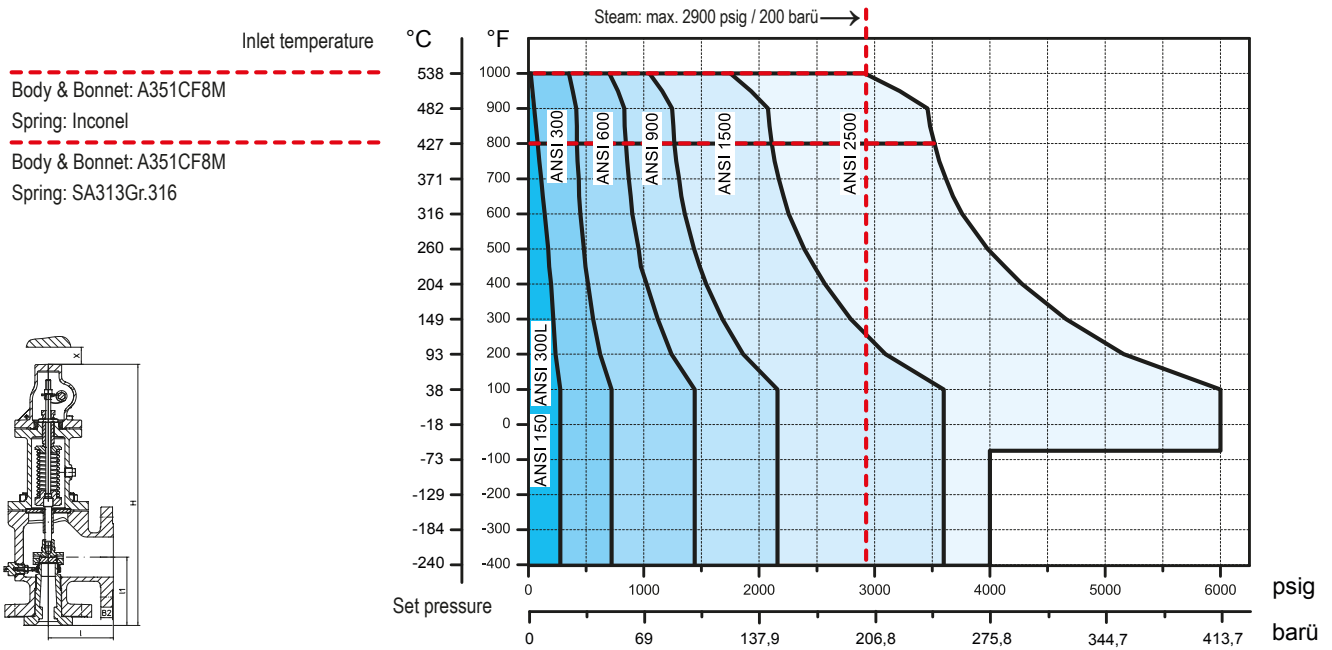

Specifications - Orifice E (effective area acc. to API: 0,196 in²)

Valve size	Material		Flangeconnection ANSI std. (RF or RTJ)		max. pressure rating limit								Dimensions				Weight				
					Inlet flange								Outlet flange	Bellows seal	I	I1		Max. H	Min. X		
					-400°F bis -76°F	-75°F bis -21°F	-20°F bis 100°F	450 °F	550 °F	800 °F	1000 °F	100 °F								100 °F	inch
inch	Body & Bonnet	Spring	Inlet Class	Outlet Class	psig	psig	psig	psig	psig	psig	psig	psig	psig	psig	psig	psig	inch	inch	inch	inch	lbs
1 E 2	SA351CF8M	SA313Gr.316	150	150	275	275	275	180	155				275	230	4 1/2	4 1/8	20	6	40		
1 E 2	SA351CF8M	Inconel	150	150					155	80	20		275	230	4 1/2	4 1/8	20	6	40		
1 E 2	SA351CF8M	SA313Gr.316	300L	150	275	275	275	275	275				275	230	4 1/2	4 1/8	20	6	43		
1 E 2	SA351CF8M	Inconel	300L	150					275	275	275		275	230	4 1/2	4 1/8	20	6	43		
1 E 2	SA351CF8M	SA313Gr.316	300	150	720	720	720	495	465				275	230	4 1/2	4 1/8	20	6	45		
1 E 2	SA351CF8M	Inconel	300	150					465	420	350		275	230	4 1/2	4 1/8	20	6	45		
1 E 2	SA351CF8M	SA313Gr.316	600	150	1440	1440	1440	975	928				275	230	4 1/2	4 1/8	20	6	45		
1 E 2	SA351CF8M	Inconel	600	150					928	845	700		275	230	4 1/2	4 1/8	20	6	45		
1.5 E 2	SA351CF8M	SA313Gr.316	900	300	2160	2160	2160	1485	1395				600	500	5 1/2	4 1/8	20	8	58		
1.5 E 2	SA351CF8M	Inconel	900	300					1395	1265	1050		600	500	5 1/2	4 1/8	20	8	58		
1.5 E 2	SA351CF8M	SA313Gr.316	1500	300	3600	3600	3600	2480	2323				600	500	5 1/2	4 1/8	20	8	58		
1.5 E 2	SA351CF8M	Inconel	1500	300					2323	2110	1750		600	500	5 1/2	4 1/8	20	8	58		
1.5 E 3	SA351CF8M	SA313Gr.316	2500	300	4000	6000	6000	4130	3870				720	500	7	5 1/2	22 1/2	10	80		
1.5 E 3	SA351CF8M	Inconel	2500	300					3870	3520	2915		720	500	7	5 1/2	22 1/2	10	80		

Center to face dimensions acc. to API 526 . Standard-flange dimensions refer to page 44.

Note

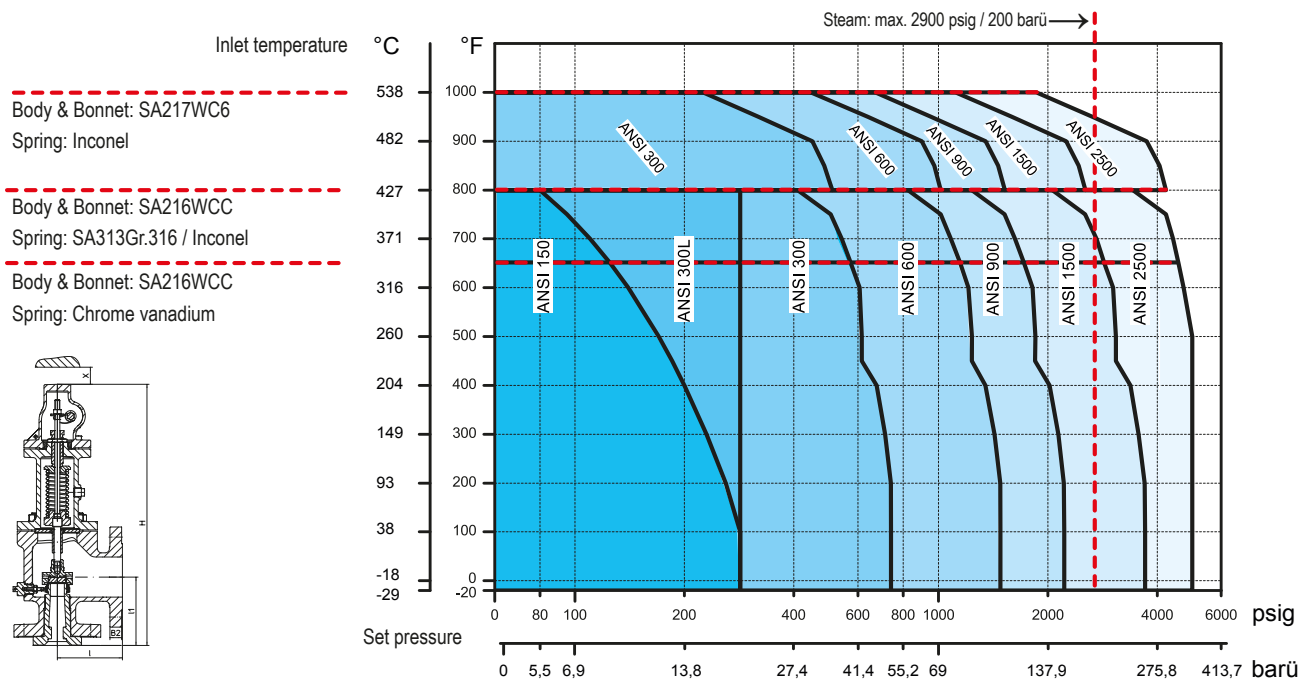
1. Valves set under 15 psig are not ASME code stamped.
2. Valve dimensions H for bellows valves add 3/4-inch. Maximum I and I1 dimensions +/- 1/16-inch
3. API526 eliminated 2 1/2-inch flange sizes, however ARI will supply 2 1/2-inch flange sizes at no additional cost.
4. Outlet pressure limit for temperatures above 100°F shall not exceed the rating in ANSI/ASME B16.34



Specifications - Orifice F (effective area acc. to API: 0,307 in²)

Valve size	Material		Flangeconnection (ANSI std. (RF or RTJ))		max. pressure rating limit							Dimensions				Weight
					Inlet flange					Outlet flange	Bellows seal	I	I1	Max. H	Min. X	
					100°F	450°F	650°F	800°F	1000°F	100°F	100°F					
inch	Body & Bonnet	Spring	Inlet Class	Outlet Class	psig	psig	psig	psig	psig	psig	psig	inch	inch	inch	inch	lbs
1.5 F 2	SA216WCC	Chr. vanad.	150	150	285	185	125			285	230	4 3/4	4 7/8	20 3/4	6	43
1.5 F 2	SA216WCC	SA313Gr.316	150	150		185	125	80		285	230	4 3/4	4 7/8	20 3/4	6	43
1.5 F 2	SA216WCC	Inconel	150	150		185	125	80		285	230	4 3/4	4 7/8	20 3/4	6	43
1.5 F 2	SA216WCC	Chr. vanad.	300L	150	285	285	285			285	230	4 3/4	4 7/8	20 3/4	6	47
1.5 F 2	SA216WCC	SA313Gr.316	300L	150		285	285	285		285	230	4 3/4	4 7/8	20 3/4	6	47
1.5 F 2	SA216WCC	Inconel	300L	150		285	285	285		285	230	4 3/4	4 7/8	20 3/4	6	47
1.5 F 2	SA216WCC	Chr. vanad.	300	150	740	615	590			285	230	6	4 7/8	20 3/4	6	50
1.5 F 2	SA216WCC	SA313Gr.316	300	150		615	590	410		285	230	6	4 7/8	20 3/4	6	50
1.5 F 2	SA216WCC	Inconel	300	150		615	590	410		285	230	6	4 7/8	20 3/4	6	50
1.5 F 2	SA217WC6	Inconel	300	150				510	215	285	230	6	4 7/8	20 3/4	6	50
1.5 F 2	SA216WCC	Chr. vanad.	600	150	1480	1235	1175			285	230	6	4 7/8	20 3/4	6	50
1.5 F 2	SA216WCC	SA313Gr.316	600	150		1235	1175	825		285	230	6	4 7/8	20 3/4	6	50
1.5 F 2	SA216WCC	Inconel	600	150		1235	1175	825		285	230	6	4 7/8	20 3/4	6	50
1.5 F 2	SA217WC6	Inconel	600	150				1015	430	285	230	6	4 7/8	20 3/4	6	50
1.5 F 3	SA216WCC	Chr. vanad.	900	300	2220	1845	1765			740	500	6 1/2	4 7/8	20 3/8	8	63
1.5 F 3	SA216WCC	SA313Gr.316	900	300		1845	1765	1235		740	500	6 1/2	4 7/8	20 3/8	8	63
1.5 F 3	SA216WCC	Inconel	900	300		1845	1765	1235		740	500	6 1/2	4 7/8	20 3/8	8	63
1.5 F 3	SA217WC6	Inconel	900	300				1525	650	740	500	6 1/2	4 7/8	20 3/8	8	63
1.5 F 3	SA216WCC	Chr. vanad.	1500	300	3705	3080	2940			740	500	6 1/2	4 7/8	21 3/4	8	68
1.5 F 3	SA216WCC	SA313Gr.316	1500	300		3080	2940	2060		740	500	6 1/2	4 7/8	21 3/4	8	68
1.5 F 3	SA216WCC	Inconel	1500	300		3080	2940	2060		740	500	6 1/2	4 7/8	21 3/4	8	68
1.5 F 3	SA217WC6	Inconel	1500	300				2540	1080	740	500	6 1/2	4 7/8	20 3/8	8	63
1.5 F 3	SA216WCC	Chr. vanad.	2500	300	5000	5000	4905			740	500	7	5 1/2	22 1/2	10	80
1.5 F 3	SA216WCC	SA313Gr.316	2500	300		5000	4905	3430		740	500	7	5 1/2	22 1/2	10	80
1.5 F 3	SA216WCC	Inconel	2500	300		5000	4905	3430		740	500	7	5 1/2	22 1/2	10	80
1.5 F 3	SA217WC6	Inconel	2500	300				4230	1800	740	500	7	5 1/2	22 1/2	10	80

Center to face dimensions acc. to API 526 .

Standard-flange dimensions refer to page 44.

Note

1. Valves set under 15 psig are not ASME code stamped.
2. Maximum I and I1 dimensions +/- 1/16-inch
3. API526 eliminated 2 1/2-inch flange sizes, however ARI will supply 2 1/2-inch flange sizes at no additional cost.
4. Outlet pressure limit for temperatures above 100°F shall not exceed the rating in ANSI/ASME B16.34

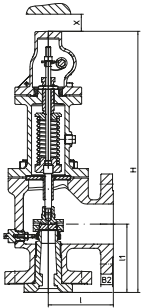
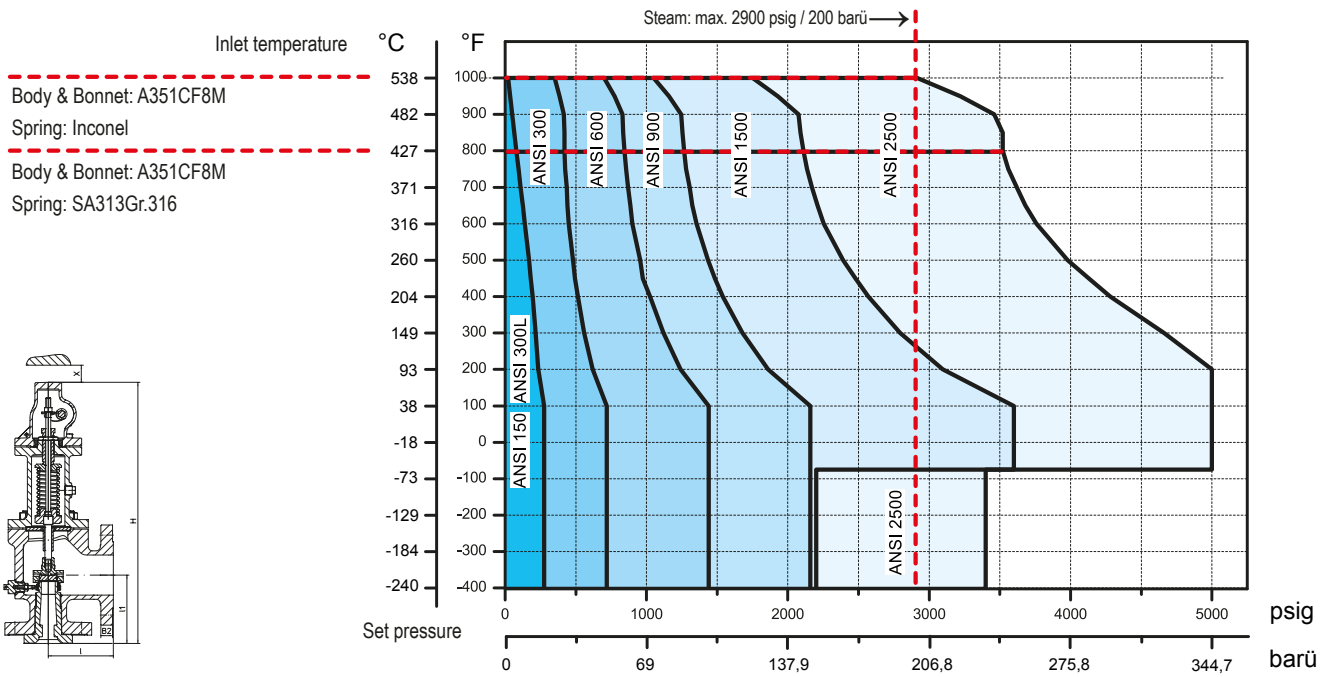

Specifications - Orifice F (effective area acc. to API: 0,307 in²)

Valve size	Material		Flangeconnection ANSI std. (RF or RTJ)		max. pressure rating limit								Dimensions				Weight		
					Inlet flange								Outlet flange	Bellows seal	I	I1		Max. H	Min. X
					-400°F bis -76°F	-75°F bis -21°F	-20°F bis 100°F	450 °F	550 °F	800 °F	1000 °F	100 °F							
inch	Body & Bonnet	Spring	Inlet Class	Outlet Class	psig	psig	psig	psig	psig	psig	psig	psig	psig	psig	inch	inch	inch	inch	lbs
1.5 F 2	SA351CF8M	SA313Gr.316	150	150	275	275	275	180	155			275	230	4 3/4	4 7/8	20 3/4	6	43	
1.5 F 2	SA351CF8M	Inconel	150	150					155	80	20	275	230	4 3/4	4 7/8	20 3/4	6	43	
1.5 F 2	SA351CF8M	SA313Gr.316	300L	150	275	275	275	275				275	230	4 3/4	4 7/8	20 3/4	6	47	
1.5 F 2	SA351CF8M	Inconel	300L	150					275	275	275	275	230	4 3/4	4 7/8	20 3/4	6	47	
1.5 F 2	SA351CF8M	SA313Gr.316	300	150	720	720	720	495	465			275	230	6	4 7/8	20 3/4	6	50	
1.5 F 2	SA351CF8M	Inconel	300	150					465	420	350	275	230	6	4 7/8	20 3/4	6	50	
1.5 F 2	SA351CF8M	SA313Gr.316	600	150	1440	1440	1440	975	928			275	230	6	4 7/8	20 3/4	6	50	
1.5 F 2	SA351CF8M	Inconel	600	150					928	845	700	275	230	6	4 7/8	20 3/4	6	50	
1.5 F 3	SA351CF8M	SA313Gr.316	900	300	2160	2160	2160	1485	1395			720	500	6 1/2	4 7/8	20 3/8	8	63	
1.5 F 3	SA351CF8M	Inconel	900	300					1395	1265	1050	720	500	6 1/2	4 7/8	20 3/8	8	63	
1.5 F 3	SA351CF8M	SA313Gr.316	1500	300	2200	3600	3600	2480	2323			720	500	6 1/2	4 7/8	21 3/4	8	68	
1.5 F 3	SA351CF8M	Inconel	1500	300					2323	2110	1750	720	500	6 1/2	4 7/8	21 3/4	8	68	
1.5 F 3	SA351CF8M	SA313Gr.316	2500	300	3400	5000	5000	4130	3870			720	500	7	5 1/2	22 1/2	10	80	
1.5 F 3	SA351CF8M	Inconel	2500	300					3870	3520	2915	720	500	7	5 1/2	22 1/2	10	80	

Center to face dimensions acc. to API 526 . Standard-flange dimensions refer to page 44.

Note

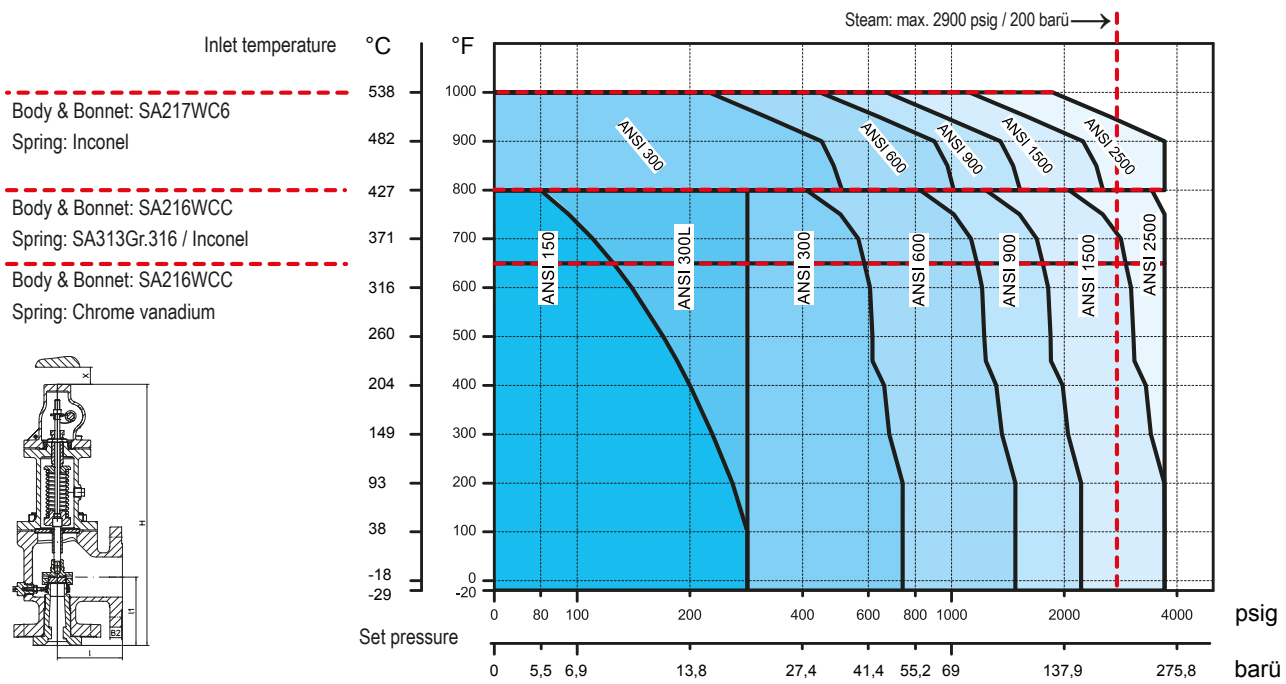
- Valves set under 15 psig are not ASME code stamped.
- Maximum I and I1 dimensions +/- 1/16-inch
- API526 eliminated 2 1/2-inch flange sizes, however ARI will supply 2 1/2-inch flange sizes at no additional cost.
- Outlet pressure limit for temperatures above 100°F shall not exceed the rating in ANSI/ASME B16.34

Specifications - Orifice G (effective area acc. to API: 0,503 in²)

Valve size	Material		Flangeconnection (ANSI std. (RF or RTJ))		max. pressure rating limit							Dimensions				Weight	
					Inlet flange					Outlet flange	Bellows seal	I	I1	Max. H	Min. X		
					Inlet Class	Outlet Class	100°F psig	450°F psig	650°F psig	800°F psig	1000°F psig	100°F psig	100°F psig	inch	inch		inch
inch	Body & Bonnet	Spring															
1.5 G 3	SA216WCC	Chr. vanad.	150	150	285	185	125				285	230	4 3/4	4 7/8	20 3/4	10	46
1.5 G 3	SA216WCC	SA313Gr.316	150	150		185	125	80			285	230	4 3/4	4 7/8	20 3/4	10	46
1.5 G 3	SA216WCC	Inconel	150	150		185	125	80			285	230	4 3/4	4 7/8	20 3/4	10	46
1.5 G 3	SA216WCC	Chr. vanad.	300L	150	285	285	285				285	230	4 3/4	4 7/8	20 3/4	10	50
1.5 G 3	SA216WCC	SA313Gr.316	300L	150		285	285	285			285	230	4 3/4	4 7/8	20 3/4	10	50
1.5 G 3	SA216WCC	Inconel	300L	150		285	285	285			285	230	4 3/4	4 7/8	20 3/4	10	50
1.5 G 3	SA216WCC	Chr. vanad.	300	150	740	615	605				285	230	6	4 7/8	20 3/4	10	55
1.5 G 3	SA216WCC	SA313Gr.316	300	150		615	605	410			285	230	6	4 7/8	20 3/4	10	55
1.5 G 3	SA216WCC	Inconel	300	150		615	605	410			285	230	6	4 7/8	20 3/4	10	55
1.5 G 3	SA217WC6	Inconel	300	150				510	215		285	230	6	4 7/8	20 3/4	10	55
1.5 G 3	SA216WCC	Chr. vanad.	600	150	1480	1235	1175				285	230	6	4 7/8	20 3/4	10	55
1.5 G 3	SA216WCC	SA313Gr.316	600	150		1235	1175	825			285	230	6	4 7/8	20 3/4	10	55
1.5 G 3	SA216WCC	Inconel	600	150		1235	1175	825			285	230	6	4 7/8	20 3/4	10	55
1.5 G 3	SA217WC6	Inconel	600	150				1015	430		285	230	6	4 7/8	20 3/4	10	55
1.5 G 3	SA216WCC	Chr. vanad.	900	300	2220	1845	1765				600	470	6 1/2	4 7/8	21 3/4	10	67
1.5 G 3	SA216WCC	SA313Gr.316	900	300		1845	1765	1235			600	470	6 1/2	4 7/8	21 3/4	10	67
1.5 G 3	SA216WCC	Inconel	900	300		1845	1765	1235			600	470	6 1/2	4 7/8	21 3/4	10	67
1.5 G 3	SA217WC6	Inconel	900	300				1525	650		600	500	6 1/2	4 7/8	21 3/4	10	67
2 G 3	SA216WCC	Chr. vanad.	1500	300	3705	3080	2940				600	470	6 3/4	6 1/8	25 1/5	12	140
2 G 3	SA216WCC	SA313Gr.316	1500	300		3080	2940	2060			600	470	6 3/4	6 1/8	25 1/5	12	140
2 G 3	SA216WCC	Inconel	1500	300		3080	2940	2060			600	470	6 3/4	6 1/8	25 1/5	12	140
2 G 3	SA217WC6	Inconel	1500	300				2540	1080		600	500	6 3/4	6 1/8	25 1/5	12	140
2 G 3	SA216WCC	Chr. vanad.	2500	300	3705	3705	3705				740	470	6 3/4	6 1/8	25 1/5	12	155
2 G 3	SA216WCC	SA313Gr.316	2500	300		3705	3705	3430			740	470	6 3/4	6 1/8	25 1/5	12	155
2 G 3	SA216WCC	Inconel	2500	300		3705	3705	3430			740	470	6 3/4	6 1/8	25 1/5	12	155
2 G 3	SA217WC6	Inconel	2500	300				3750	1800		740	500	6 3/4	6 1/8	25 1/5	12	155

Center to face dimensions acc. to API 526.

Standard-flange dimensions refer to page 44.

Note

1. Valves set under 15 psig are not ASME code stamped.
2. Maximum I and I1 dimensions +/- 1/16-inch
3. API526 eliminated 2 1/2-inch flange sizes, however ARI will supply 2 1/2-inch flange sizes at no additional cost.
4. Outlet pressure limit for temperatures above 100°F shall not exceed the rating in ANSI/ASME B16.34

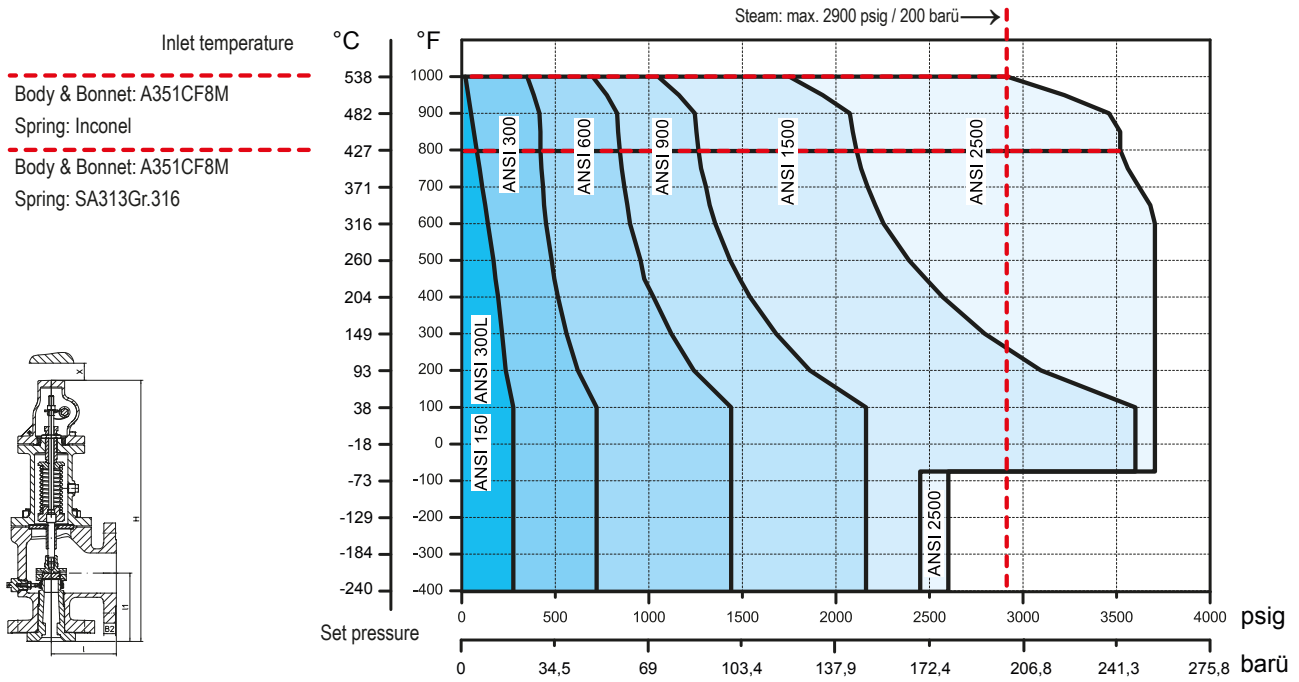

Specifications - Orifice G (effective area acc. to API: 0,503 in²)

Valve size	Material		Flangeconnection ANSI std. (RF or RTJ)		max. pressure rating limit								Dimensions				Weight		
					Inlet flange								Outlet flange	Bellows seal	I	I1		Max. H	Min. X
					-400°F bis -76°F	-75°F bis -21°F	-20°F bis 100°F	450 °F	550 °F	800 °F	1000 °F	100 °F							
inch	Body & Bonnet	Spring	Inlet Class	Outlet Class	psig	psig	psig	psig	psig	psig	psig	psig	psig	psig	inch	inch	inch	inch	lbs
1.5 G 3	SA351CF8M	SA313Gr.316	150	150	275	275	275	180	155			275	230	4 3/4	4 7/8	20 3/4	10	46	
1.5 G 3	SA351CF8M	Inconel	150	150					155	80	20	275	230	4 3/4	4 7/8	20 3/4	10	46	
1.5 G 3	SA351CF8M	SA313Gr.316	300L	150	275	275	275	275	275			275	230	4 3/4	4 7/8	20 3/4	10	50	
1.5 G 3	SA351CF8M	Inconel	300L	150					275	275	275	275	230	4 3/4	4 7/8	20 3/4	10	50	
1.5 G 3	SA351CF8M	SA313Gr.316	300	150	720	720	720	495	465			275	230	6	4 7/8	20 3/4	10	55	
1.5 G 3	SA351CF8M	Inconel	300	150					465	420	350	275	230	6	4 7/8	20 3/4	10	55	
1.5 G 3	SA351CF8M	SA313Gr.316	600	150	1440	1440	1440	975	928			275	230	6	4 7/8	20 3/4	10	55	
1.5 G 3	SA351CF8M	Inconel	600	150					928	845	700	275	230	6	4 7/8	20 3/4	10	55	
1.5 G 3	SA351CF8M	SA313Gr.316	900	300	2160	2160	2160	1485	1395			720	500	6 1/2	4 7/8	21 3/4	10	67	
1.5 G 3	SA351CF8M	Inconel	900	300					1395	1265	1050	720	500	6 1/2	4 7/8	21 3/4	10	67	
2 G 3	SA351CF8M	SA313Gr.316	1500	300	2450	3600	3600	2480	2323			720	500	6 3/4	6 1/8	25 1/5	12	140	
2 G 3	SA351CF8M	Inconel	1500	300					2323	2110	1750	720	500	6 3/4	6 1/8	25 1/5	12	140	
2 G 3	SA351CF8M	SA313Gr.316	2500	300	2600	3705	3705	3705	3705			720	500	6 3/4	6 1/8	25 1/5	12	155	
2 G 3	SA351CF8M	Inconel	2500	300					3705	3520	2915	720	500	6 3/4	6 1/8	25 1/5	12	155	

Center to face dimensions acc. to API 526. Standard-flange dimensions refer to page 44.

Note

- Valves set under 15 psig are not ASME code stamped.
- Maximum I and I1 dimensions +/- 1/16-inch
- API526 eliminated 2 1/2-inch flange sizes, however ARI will supply 2 1/2-inch flange sizes at no additional cost.
- Outlet pressure limit for temperatures above 100°F shall not exceed the rating in ANSI/ASME B16.34

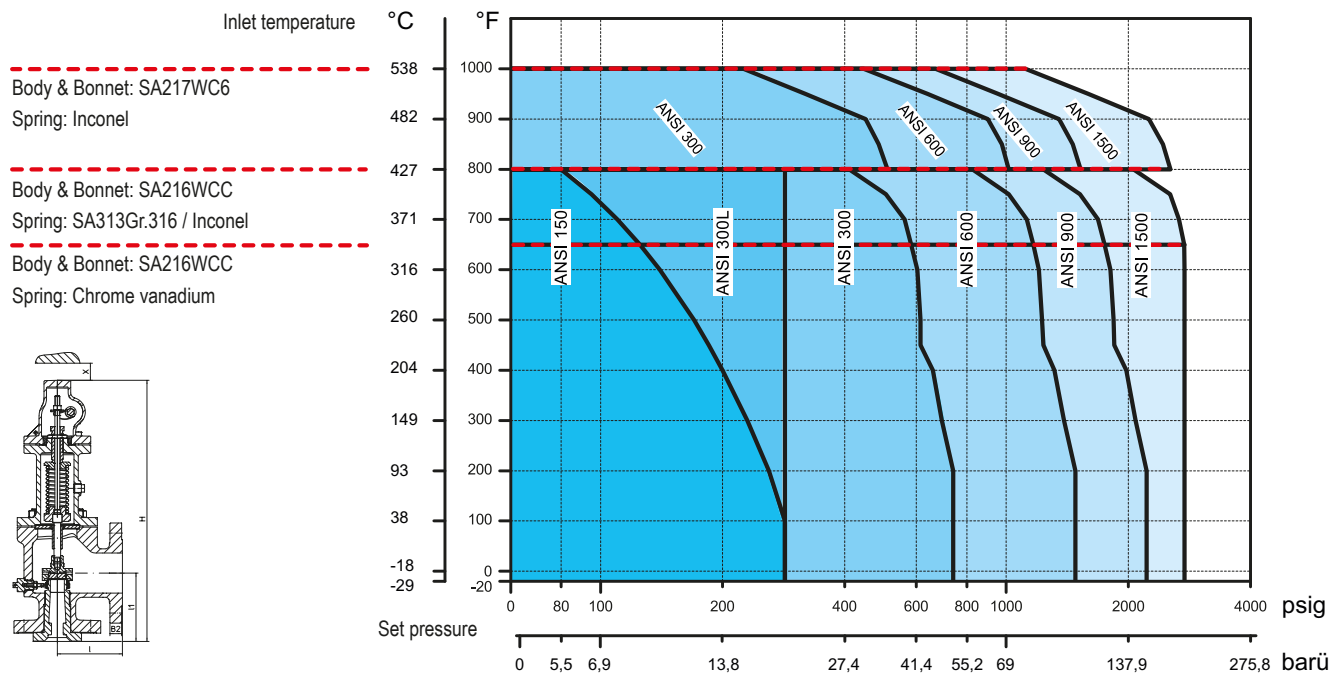

Specifications - Orifice H (effective area acc. to API: 0,785 in²)

Valve size	Material		Flangeconnection ANSI std. (RF or RTJ)		max. pressure rating limit							Dimensions				Weight		
					Inlet flange					Outlet flange	Bellows seal	I	I1	Max. H	Min. X			
					Inlet Class	Outlet Class	100°F	450°F	650°F	800°F	1000°F	100°F	100°F	inch	inch		inch	inch
inch	Body & Bonnet	Spring	Class	Class	psig	psig	psig	psig	psig	psig	psig	psig	psig	inch	inch	inch	inch	lbs
1.5 H 3	SA216WCC	Chr. vanad.	150	150	285	185	125				285	230	4 7/8	5 1/8	21	10	50	
1.5 H 3	SA216WCC	SA313Gr.316	150	150		185	125	80			285	230	4 7/8	5 1/8	21	10	50	
1.5 H 3	SA216WCC	Inconel	150	150		185	125	80			285	230	4 7/8	5 1/8	21	10	50	
1.5 H 3	SA216WCC	Chr. vanad.	300L	150	285	285	285				285	230	4 7/8	5 1/8	21	10	54	
1.5 H 3	SA216WCC	SA313Gr.316	300L	150		285	285	285			285	230	4 7/8	5 1/8	21	10	54	
1.5 H 3	SA216WCC	Inconel	300L	150		285	285	285			285	230	4 7/8	5 1/8	21	10	54	
2 H 3	SA216WCC	Chr. vanad.	300	150	740	615	590				285	230	4 7/8	5 1/8	21	12	58	
2 H 3	SA216WCC	SA313Gr.316	300	150		615	590	410			285	230	4 7/8	5 1/8	21	12	58	
2 H 3	SA216WCC	Inconel	300	150		615	590	410			285	230	4 7/8	5 1/8	21	12	58	
2 H 3	SA217WC6	Inconel	300	150				510	215		285	230	4 7/8	5 1/8	21	12	58	
2 H 3	SA216WCC	Chr. vanad.	600	150	1480	1235	1175				285	230	6 3/8	6 1/16	25 1/2	12	120	
2 H 3	SA216WCC	SA313Gr.316	600	150		1235	1175	825			285	230	6 3/8	6 1/16	25 1/2	12	120	
2 H 3	SA216WCC	Inconel	600	150		1235	1175	825			285	230	6 3/8	6 1/16	25 1/2	12	120	
2 H 3	SA217WC6	Inconel	600	150				1015	430		285	230	4 7/8	5 1/8	21	12	60	
2 H 3	SA216WCC	Chr. vanad.	900	150	2220	1845	1765				285	230	6 3/8	6 1/16	25 1/2	12	135	
2 H 3	SA216WCC	SA313Gr.316	900	150		1845	1765	1235			285	230	6 3/8	6 1/16	25 1/2	12	135	
2 H 3	SA216WCC	Inconel	900	150		1845	1765	1235			285	230	6 3/8	6 1/16	25 1/2	12	135	
2 H 3	SA217WC6	Inconel	900	150				1525	650		285	230	6 3/8	6 1/16	25 1/2	12	135	
2 H 3	SA216WCC	Chr. vanad.	1500	300	2750	2750	2745				740	415	6 3/8	6 1/16	25 1/2	12	140	
2 H 3	SA216WCC	SA313Gr.316	1500	300		2750	2745	2060			740	415	6 3/8	6 1/16	25 1/2	12	140	
2 H 3	SA216WCC	Inconel	1500	300		2750	2745	2060			740	415	6 3/8	6 1/16	25 1/2	12	140	
2 H 3	SA217WC6	Inconel	1500	300				2540	1080		740	415	6 3/8	6 1/16	25 1/2	12	140	

Center to face dimensions acc. to API 526.

Standard-flange dimensions refer to page 44.

Note

1. Valves set under 15 psig are not ASME code stamped.
2. Maximum I and I1 dimensions +/- 1/16-inch
3. Outlet pressure limit for temperatures above 100°F shall not exceed the rating in ANSI/ASME B16.34

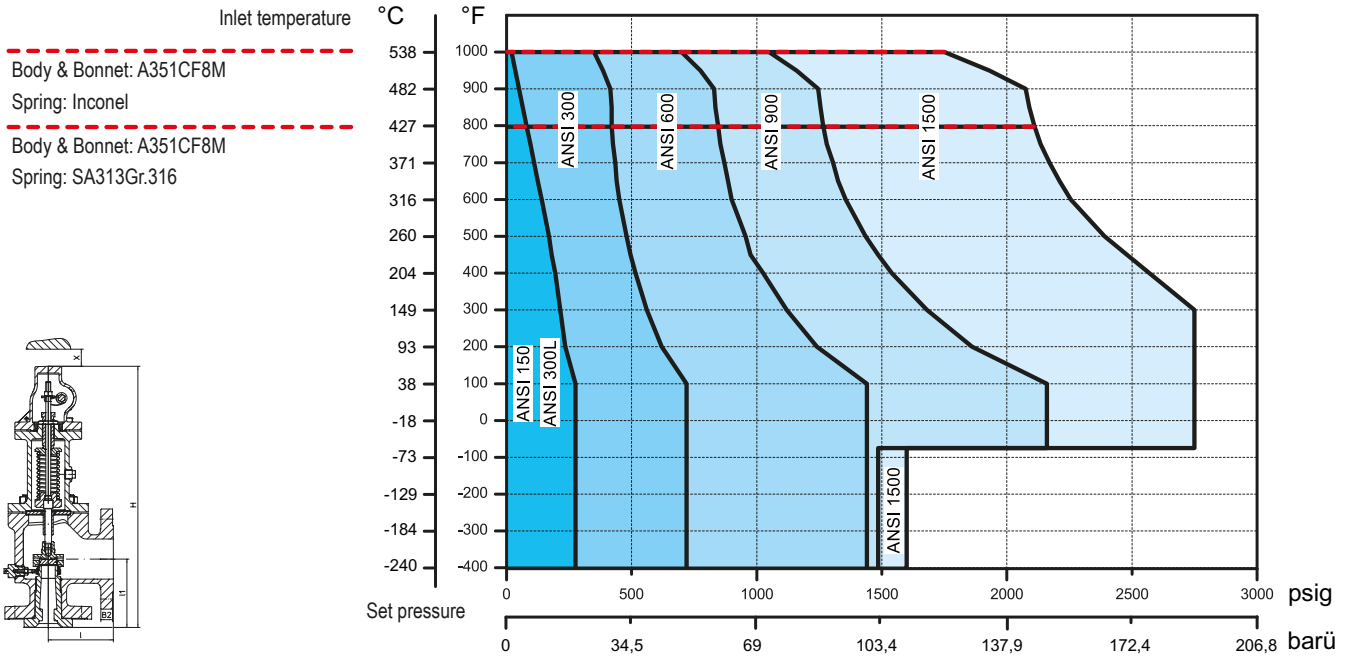

Specifications - Orifice H (effective area acc. to API: 0,785 in²)

Valve size	Material		Flangeconnection ANSI std. (RF or RTJ)		max. pressure rating limit								Dimensions				Weight		
					Inlet flange								Outlet flange	Bellows seal	I	I1		Max. H	Min. X
					-400°F bis -76°F	-75°F bis -21°F	-20°F bis 100°F	450 °F	550 °F	800 °F	1000 °F	100 °F							
inch	Body & Bonnet	Spring	Inlet Class	Outlet Class	psig	psig	psig	psig	psig	psig	psig	psig	psig	psig	inch	inch	inch	inch	lbs
1.5 H 3	SA351CF8M	SA313Gr.316	150	150	275	275	275	180	155			275	230	4 7/8	5 1/8	21	10	50	
1.5 H 3	SA351CF8M	Inconel	150	150					155	80	20	275	230	4 7/8	5 1/8	21	10	50	
1.5 H 3	SA351CF8M	SA313Gr.316	300L	150	275	275	275	275				275	230	4 7/8	5 1/8	21	10	54	
1.5 H 3	SA351CF8M	Inconel	300L	150					275	275	275	275	230	4 7/8	5 1/8	21	10	54	
2 H 3	SA351CF8M	SA313Gr.316	300	150	720	720	720	495	465			275	230	4 7/8	5 1/8	21	12	58	
2 H 3	SA351CF8M	Inconel	300	150					465	420	350	275	230	4 7/8	5 1/8	21	12	58	
2 H 3	SA351CF8M	SA313Gr.316	600	150	1440	1440	1440	975	928			275	230	6 3/8	6 1/16	25 1/2	12	120	
2 H 3	SA351CF8M	Inconel	600	150					928	845	700	275	230	6 3/8	6 1/16	25 1/2	12	120	
2 H 3	SA351CF8M	SA313Gr.316	900	150	1485	2160	2160	1485	1395			275	230	6 3/8	6 1/16	25 1/2	12	135	
2 H 3	SA351CF8M	Inconel	900	150					1395	1265	1050	275	230	6 3/8	6 1/16	25 1/2	12	135	
2 H 3	SA351CF8M	SA313Gr.316	1500	300	1600	2750	2750	2480	2323			600	415	6 3/8	6 1/16	25 1/2	12	140	
2 H 3	SA351CF8M	Inconel	1500	300					2323	2110	1750	600	415	6 3/8	6 1/16	25 1/2	12	140	

Center to face dimensions acc. to API 526. Standard-flange dimensions refer to page 44.

Note

- Valves set under 15 psig are not ASME code stamped.
- Maximum I and I1 dimensions +/- 1/16-inch
- Outlet pressure limit for temperatures above 100°F shall not exceed the rating in ANSI/ASME B16.34

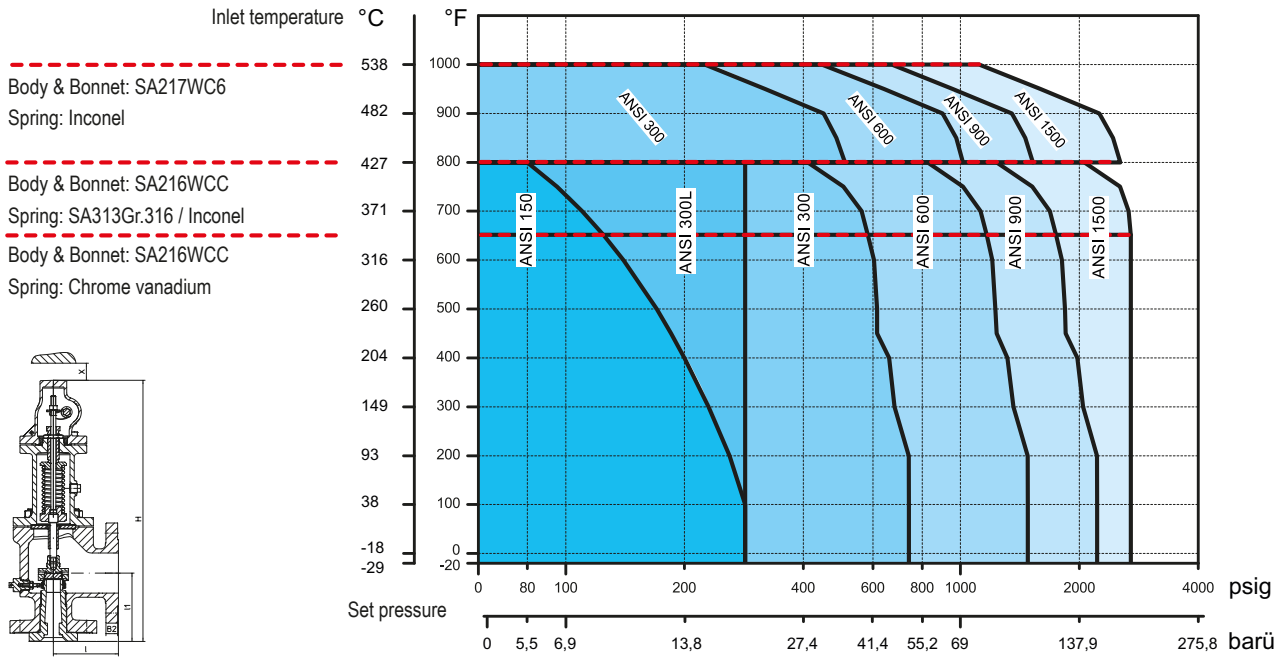

Specifications - Orifice J (effective area acc. to API: 1,287 in²)

Valve size	Material		Flangeconnection ANSI std. (RF or RTJ)		max. pressure rating limit							Dimensions				Weight	
					Inlet flange					Outlet flange	Bellows seal	I	I1	Max. H	Min. X		
					100°F	450°F	650°F	800°F	1000°F	100°F	100°F						
inch	Body & Bonnet	Spring	Inlet Class	Outlet Class	psig	psig	psig	psig	psig	psig	psig	inch	inch	inch	inch	lbs	
2 J 3	SA216WCC	Chr. vanad.	150	150	285	185	125				285	230	4 7/8	5 3/8	21 3/4	12	58
2 J 3	SA216WCC	SA313Gr.316	150	150		185	125	80			285	230	4 7/8	5 3/8	21 3/4	12	58
2 J 3	SA216WCC	Inconel	150	150		185	125	80			285	230	4 7/8	5 3/8	21 3/4	12	58
2 J 3	SA216WCC	Chr. vanad.	300L	150	285	285	285				285	230	4 7/8	5 3/8	21 3/4	12	62
2 J 3	SA216WCC	SA313Gr.316	300L	150		285	285	285			285	230	4 7/8	5 3/8	21 3/4	12	62
2 J 3	SA216WCC	Inconel	300L	150		285	285	285			285	230	4 7/8	5 3/8	21 3/4	12	62
3 J 4	SA216WCC	Chr. vanad.	300	150	740	615	590				285	230	7 1/8	7 1/4	22 3/4	14	76
3 J 4	SA216WCC	SA313Gr.316	300	150		615	590	410			285	230	7 1/8	7 1/4	22 3/4	14	76
3 J 4	SA216WCC	Inconel	300	150		615	590	410			285	230	7 1/8	7 1/4	22 3/4	14	76
3 J 4	SA217WC6	Inconel	300	150				510	215		285	230	7 1/8	7 1/4	22 3/4	14	76
3 J 4	SA216WCC	Chr. vanad.	600	150	1480	1235	1175				285	230	7 1/8	7 1/4	30 1/2	14	205
3 J 4	SA216WCC	SA313Gr.316	600	150		1235	1175	825			285	230	7 1/8	7 1/4	30 1/2	14	205
3 J 4	SA216WCC	Inconel	600	150		1235	1175	825			285	230	7 1/8	7 1/4	30 1/2	14	205
3 J 4	SA217WC6	Inconel	600	150				1015	430		285	230	7 1/8	7 1/4	30 1/2	14	205
3 J 4	SA216WCC	Chr. vanad.	900	150	2220	1845	1765				285	230	7 1/8	7 1/4	30 1/2	14	205
3 J 4	SA216WCC	SA313Gr.316	900	150		1845	1765	1235			285	230	7 1/8	7 1/4	30 1/2	14	205
3 J 4	SA216WCC	Inconel	900	150		1845	1765	1235			285	230	7 1/8	7 1/4	30 1/2	14	205
3 J 4	SA217WC6	Inconel	900	150				1525	650		285	230	7 1/8	7 1/4	30 1/2	14	205
3 J 4	SA216WCC	Chr. vanad.	1500	300	2700	2700					600	230	7 1/8	7 1/4	30 1/2	14	235
3 J 4	SA216WCC	SA313Gr.316	1500	300		2700	2700	2060			600	230	7 1/8	7 1/4	30 1/2	14	235
3 J 4	SA216WCC	Inconel	1500	300		2700	2700	2060			600	230	7 1/8	7 1/4	30 1/2	14	235
3 J 4	SA217WC6	Inconel	1500	300				2540	1080		600	230	7 1/8	7 1/4	30 1/2	14	235

Center to face dimensions acc. to API 526.

Standard-flange dimensions refer to page 44.

Note

1. Valves set under 15 psig are not ASME code stamped.
2. Maximum I and I1 dimensions +/- 1/16-inch
3. API526 eliminated 2 1/2-inch flange sizes, however ARI will supply 2 1/2-inch flange sizes at no additional cost.
4. Outlet pressure limit for temperatures above 100°F shall not exceed the rating in ANSI/ASME B16.34

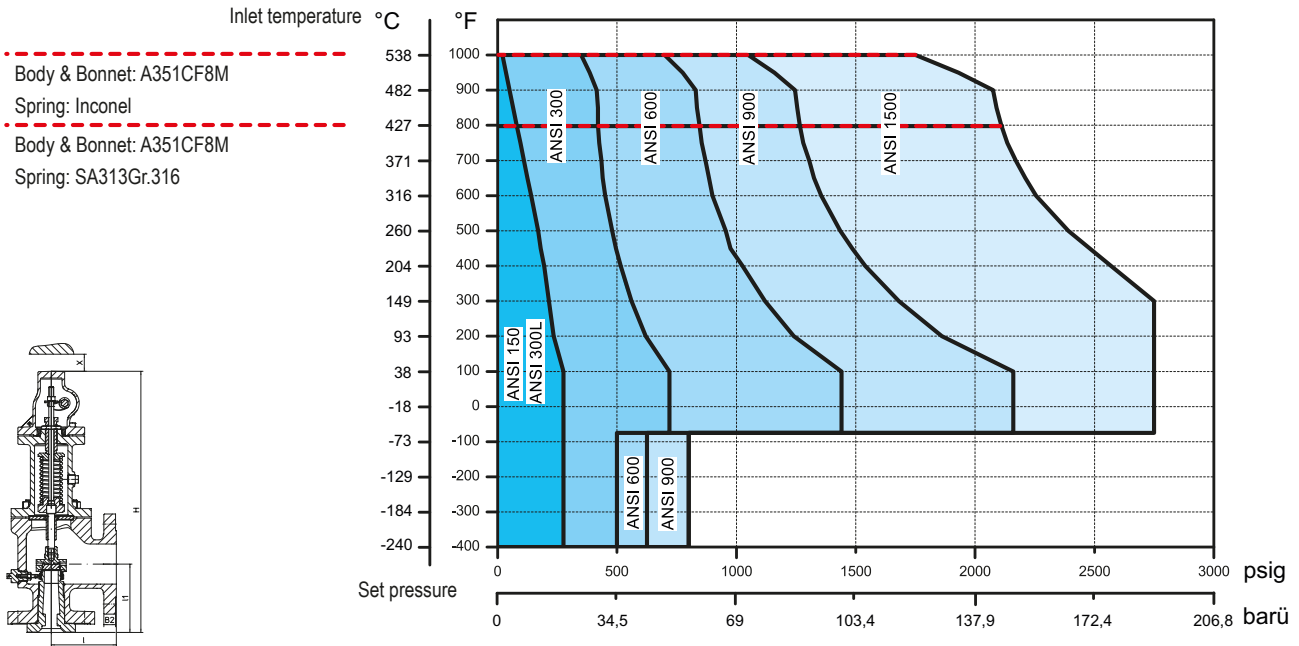

Specifications - Orifice J (effective area acc. to API: 1,287 in²)

Valve size	Material		Flangeconnection ANSI std. (RF or RTJ)		max. pressure rating limit								Dimensions				Weight		
					Inlet flange		Outlet flange	Bellows seal	I	I1	Max. H	Min. X							
					-400°F bis -76°F	-75°F bis -21°F							-20°F bis 100°F	450 °F	550 °F	800 °F		1000 °F	100 °F
inch	Body & Bonnet	Spring	Inlet Class	Outlet Class	psig	psig	psig	psig	psig	psig	psig	psig	psig	psig	inch	inch	inch	inch	lbs
2 J 3	SA351CF8M	SA313Gr.316	150	150	275	275	275	180	155			275	230	4 7/8	5 3/8	21 3/4	12	58	
2 J 3	SA351CF8M	Inconel	150	150					155	80	20	275	230	4 7/8	5 3/8	21 3/4	12	58	
2 J 3	SA351CF8M	SA313Gr.316	300L	150	275	275	275	275	275			275	230	4 7/8	5 3/8	21 3/4	12	62	
2 J 3	SA351CF8M	Inconel	300L	150					275	275	275	275	230	4 7/8	5 3/8	21 3/4	12	62	
3 J 4	SA351CF8M	SA313Gr.316	300	150	500	720	720	495	465			275	230	7 1/8	7 1/4	22 3/4	14	76	
3 J 4	SA351CF8M	Inconel	300	150					465	420	350	275	230	7 1/8	7 1/4	22 3/4	14	76	
3 J 4	SA351CF8M	SA313Gr.316	600	150	625	1440	1440	975	928			275	230	7 1/8	7 1/4	30 1/2	14	205	
3 J 4	SA351CF8M	Inconel	600	150					928	845	700	275	230	7 1/8	7 1/4	30 1/2	14	205	
3 J 4	SA351CF8M	SA313Gr.316	900	150	800	2160	2160	1485	1395			275	230	7 1/8	7 1/4	30 1/2	14	205	
3 J 4	SA351CF8M	Inconel	900	150					1395	1265	1050	275	230	7 1/8	7 1/4	30 1/2	14	205	
3 J 4	SA351CF8M	SA313Gr.316	1500	300	800	2750	2750	2480	2323			600	230	7 1/8	7 1/4	30 1/2	14	235	
3 J 4	SA351CF8M	Inconel	1500	300					2323	2110	1750	600	230	7 1/8	7 1/4	30 1/2	14	235	

Center to face dimensions acc. to API 526. Standard-flange dimensions refer to page 44.

Note

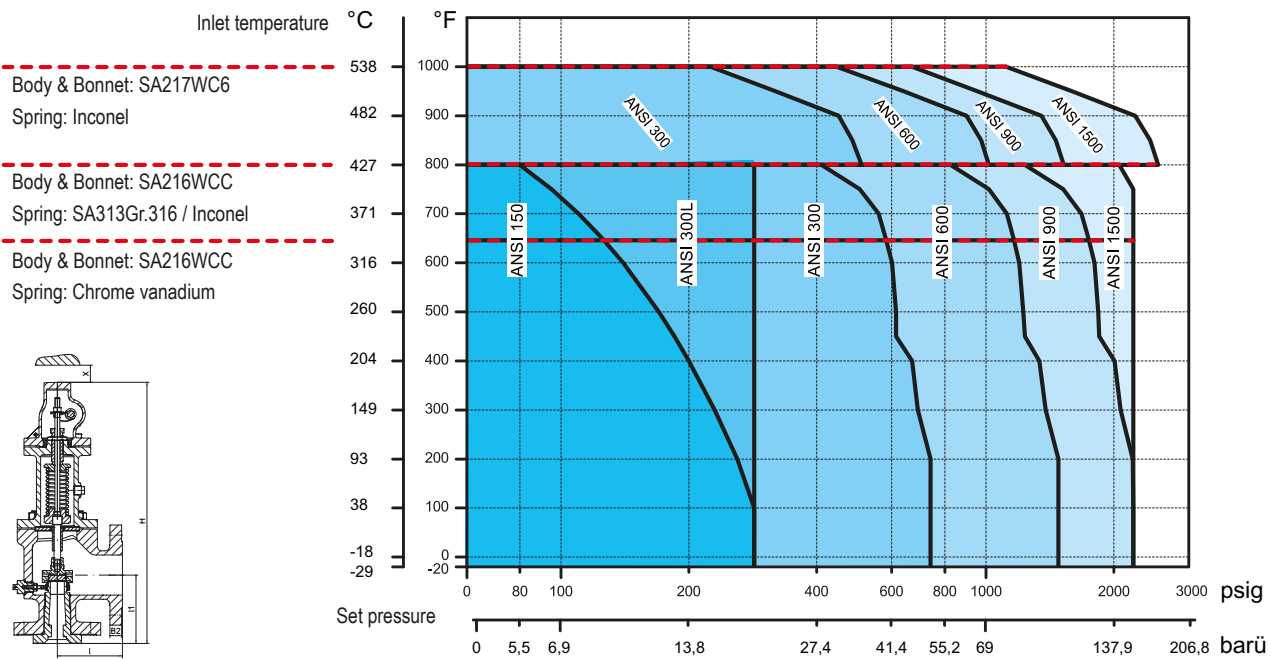
- Valves set under 15 psig are not ASME code stamped.
- Maximum I and I1 dimensions +/- 1/16-inch
- API526 eliminated 2 1/2-inch flange sizes, however ARI will supply 2 1/2-inch flange sizes at no additional cost.
- Outlet pressure limit for temperatures above 100°F shall not exceed the rating in ANSI/ASME B16.34



Specifications - Orifice K (effective area acc. to API: 1,838 in²)

Valve size	Material		Flangeconnection ANSI std. (RF or RTJ)		max. pressure rating limit							Dimensions				Weight	
					Inlet flange					Outlet flange	Bellows seal	I	I1	Max. H	Min. X		
					Inlet Class	Outlet Class	100°F psig	450°F psig	650°F psig	800°F psig	1000°F psig	100°F psig	100°F psig	inch	inch		inch
inch	Body & Bonnet	Spring															
3 K 4	SA216WCC	Chr. vanad.	150	150	285	185	125				285	150	6 3/8	6 1/8	26 1/2	14	120
3 K 4	SA216WCC	SA313Gr.316	150	150		185	125	80			285	150	6 3/8	6 1/8	26 1/2	14	120
3 K 4	SA216WCC	Inconel	150	150		185	125	80			285	150	6 3/8	6 1/8	26 1/2	14	120
3 K 4	SA216WCC	Chr. vanad.	300L	150	285	285	285				285	150	6 3/8	6 1/8	26 1/2	14	130
3 K 4	SA216WCC	SA313Gr.316	300L	150		285	285	285			285	150	6 3/8	6 1/8	26 1/2	14	130
3 K 4	SA216WCC	Inconel	300L	150		285	285	285			285	150	6 3/8	6 1/8	26 1/2	14	130
3 K 4	SA216WCC	Chr. vanad.	300	150	740	615	590				285	150	6 3/8	6 1/8	26 1/2	14	135
3 K 4	SA216WCC	SA313Gr.316	300	150		615	590	410			285	150	6 3/8	6 1/8	26 1/2	14	135
3 K 4	SA216WCC	Inconel	300	150		615	590	410			285	150	6 3/8	6 1/8	26 1/2	14	135
3 K 4	SA217WC6	Inconel	300	150				510	215		285	150	6 3/8	6 1/8	26 1/2	14	135
3 K 4	SA216WCC	Chr. vanad.	600	150	1480	1235	1175				285	200	7 1/8	7 1/4	30 1/2	14	185
3 K 4	SA216WCC	SA313Gr.316	600	150		1235	1175	825			285	200	7 1/8	7 1/4	30 1/2	14	185
3 K 4	SA216WCC	Inconel	600	150		1235	1175	825			285	200	7 1/8	7 1/4	30 1/2	14	185
3 K 4	SA217WC6	Inconel	600	150				1015	430		285	200	7 1/8	7 1/4	26 1/2	14	135
3 K 6	SA216WCC	Chr. vanad.	900	150	2220	1845	1765				285	200	8 1/2	7 13/16	34 1/4	20	215
3 K 6	SA216WCC	SA313Gr.316	900	150		1845	1765	1235			285	200	8 1/2	7 13/16	34 1/4	20	215
3 K 6	SA216WCC	Inconel	900	150		1845	1765	1235			285	200	8 1/2	7 13/16	34 1/4	20	215
3 K 4	SA217WC6	Inconel	900	150				1525	650		285	230	8 1/2	7 13/16	30 1/2	20	185
3 K 6	SA216WCC	Chr. vanad.	1500	300	2220	2220	2220				600	200	8 1/2	7 3/4	34 1/4	20	255
3 K 6	SA216WCC	SA313Gr.316	1500	300		2220	2220	2060			600	200	8 1/2	7 3/4	34 1/4	20	255
3 K 6	SA216WCC	Inconel	1500	300		2220	2220	2060			600	200	8 1/2	7 3/4	34 1/4	20	255
3 K 4	SA217WC6	Inconel	1500	300				2220	1080		600	230	8 1/2	7 3/4	34 1/4	20	255

Center to face dimensions acc. to API 526. Standard-flange dimensions refer to page 44.

Note

1. Valves set under 15 psig are not ASME code stamped.
2. Maximum I and I1 dimensions +/- 1/16-inch
3. API526 eliminated 2 1/2-inch flange sizes, however ARI will supply 2 1/2-inch flange sizes at no additional cost.
4. Outlet pressure limit for temperatures above 100°F shall not exceed the rating in ANSI/ASME B16.34

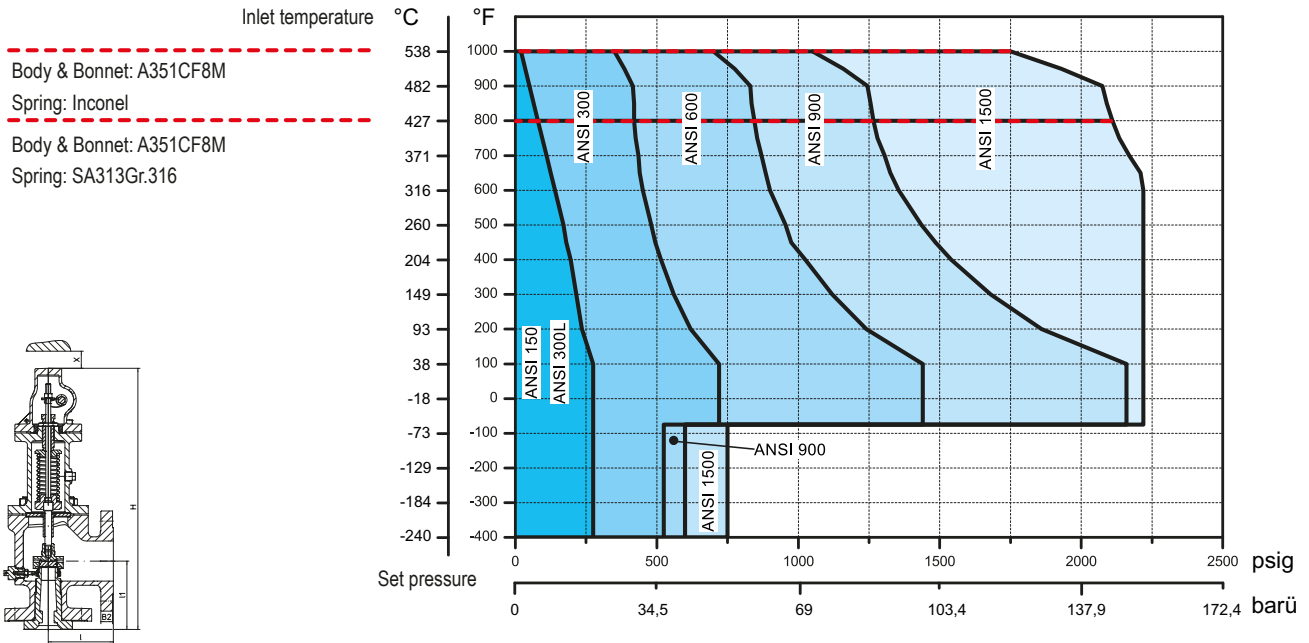
Specifications - Orifice K (effective area acc. to API: 1,838 in²)

Valve size	Material		Flangeconnection ANSI std. (RF or RTJ)		max. pressure rating limit								Dimensions				Weight		
					Inlet flange						Outlet flange	Bellows seal	I	I1	Max. H	Min. X			
					Inlet	Outlet	-400°F bis -76°F	-75°F bis -21°F	-20°F bis 100°F	450 °F								550 °F	800 °F
inch	Body & Bonnet	Spring	Class	Class	psig	psig	psig	psig	psig	psig	psig	psig	psig	psig	inch	inch	inch	inch	lbs
3 K 4	SA351CF8M	SA313Gr.316	150	150	275	275	275	180	155			275	230	6 3/8	6 1/8	26 1/2	14	120	
3 K 4	SA351CF8M	Inconel	150	150					155	80	20	275	230	6 3/8	6 1/8	26 1/2	14	120	
3 K 4	SA351CF8M	SA313Gr.316	300L	150	275	275	275	275	275			275	230	6 3/8	6 1/8	26 1/2	14	130	
3 K 4	SA351CF8M	Inconel	300L	150					275	275	275	275	230	6 3/8	6 1/8	26 1/2	14	130	
3 K 4	SA351CF8M	SA313Gr.316	300	150	525	720	720	495	465			275	230	6 3/8	6 1/8	26 1/2	14	135	
3 K 4	SA351CF8M	Inconel	300	150					465	420	350	275	230	6 3/8	6 1/8	26 1/2	14	135	
3 K 4	SA351CF8M	SA313Gr.316	600	150	600	1440	1440	975	928			275	230	7 1/8	7 1/4	30 1/2	14	185	
3 K 4	SA351CF8M	Inconel	600	150					928	845	700	275	230	7 1/8	7 1/4	30 1/2	14	185	
3 K 6	SA351CF8M	SA313Gr.316	900	150	600	2160	2160	1485	1395			275	230	8 1/2	7 13/16	34 1/4	20	215	
3 K 6	SA351CF8M	Inconel	900	150					1395	1265	1050	275	230	8 1/2	7 13/16	34 1/4	20	215	
3 K 6	SA351CF8M	SA313Gr.316	1500	300	750	2220	2220	2220	2220			600	230	8 1/2	7 3/4	34 1/4	20	255	
3 K 6	SA351CF8M	Inconel	1500	300					2220	2110	1750	600	230	8 1/2	7 3/4	34 1/4	20	255	

Center to face dimensions acc. to API 526.

Standard-flange dimensions refer to page 44.

Note

1. Valves set under 15 psig are not ASME code stamped.
2. Maximum I and I1 dimensions +/- 1/16-inch
3. API526 eliminated 2 1/2-inch flange sizes, however ARI will supply 2 1/2-inch flange sizes at no additional cost.
4. Outlet pressure limit for temperatures above 100°F shall not exceed the rating in ANSI/ASME B16.34

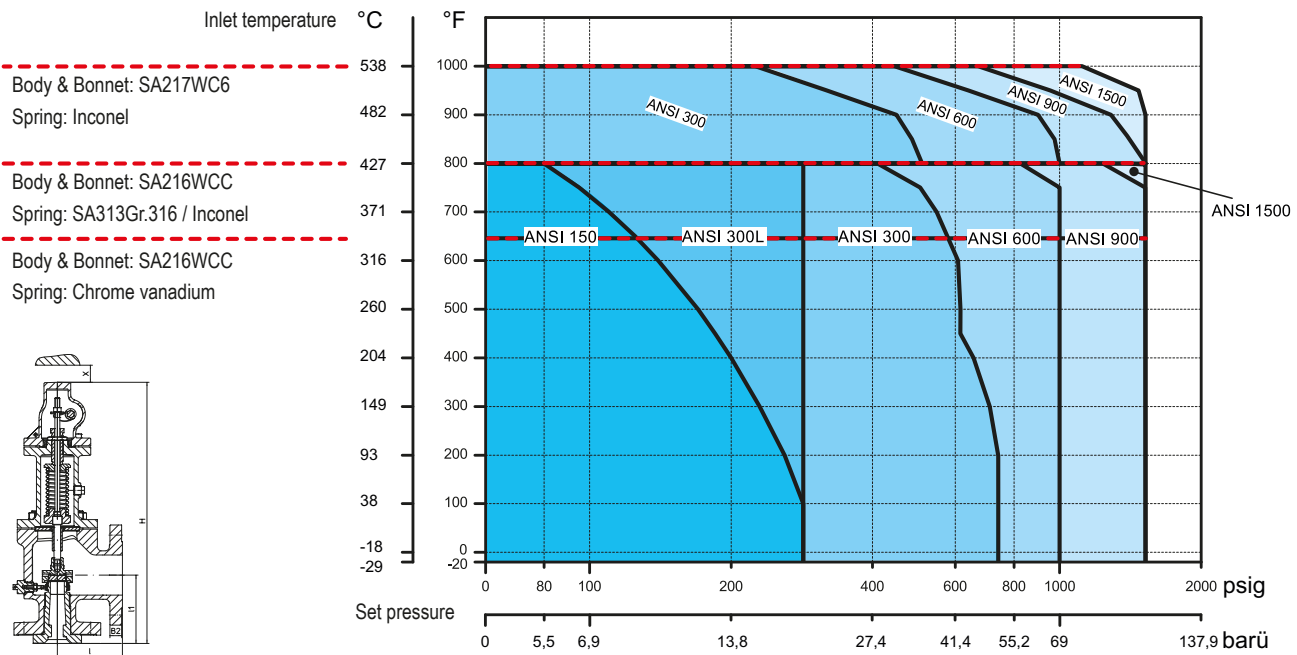

Specifications - Orifice L (effective area acc. to API: 2,853 in²)

Valve size	Material		Flangeconnection ANSI std. (RF or RTJ)		max. pressure rating limit							Dimensions				Weight	
					Inlet flange					Outlet flange	Bellows seal	I	I1	Max. H	Min. X		
					100°F	450°F	650°F	800°F	1000°F	100°F	100°F	inch	inch	inch	inch		
inch	Body & Bonnet	Spring	Inlet Class	Outlet Class	psig	psig	psig	psig	psig	psig	psig	psig	inch	inch	inch	inch	lbs
3 L 4	SA216WCC	Chr. vanad.	150	150	285	185	125			285	100	6 1/2	6 1/8	26 1/2	14	130	
3 L 4	SA216WCC	SA313Gr.316	150	150		185	125	80		285	100	6 1/2	6 1/8	26 1/2	14	130	
3 L 4	SA216WCC	Inconel	150	150		185	125	80		285	100	6 1/2	6 1/8	26 1/2	14	130	
3 L 4	SA216WCC	Chr. vanad.	300L	150	285	285	285			285	100	6 1/2	6 1/8	26 1/2	14	140	
3 L 4	SA216WCC	SA313Gr.316	300L	150			285	285		285	100	6 1/2	6 1/8	26 1/2	14	140	
3 L 4	SA216WCC	Inconel	300L	150		285	285	285		285	100	6 1/2	6 1/8	26 1/2	14	140	
4 L 6	SA216WCC	Chr. vanad.	300	150	740	615	590			285	170	7 1/8	7 1/16	30 1/4	20	200	
4 L 6	SA216WCC	SA313Gr.316	300	150		615	590	410		285	170	7 1/8	7 1/16	30 1/4	20	200	
4 L 6	SA216WCC	Inconel	300	150		615	590	410		285	170	7 1/8	7 1/16	30 1/4	20	200	
4 L 6	SA217WC6	Inconel	300	150				510	215	285	170	7 1/8	7 1/16	30 1/4	20	200	
4 L 6	SA216WCC	Chr. vanad.	600	150	1000	1000	1000			285	170	8	7 1/16	30 1/4	20	220	
4 L 6	SA216WCC	SA313Gr.316	600	150		1000	1000	825		285	170	8	7 1/16	30 1/4	20	220	
4 L 6	SA216WCC	Inconel	600	150		1000	1000	825		285	170	8	7 1/16	30 1/4	20	220	
4 L 6	SA217WC6	Inconel	600	150				1000	430	285	170	8	7 1/16	30 1/4	20	220	
4 L 6	SA216WCC	Chr. vanad.	900	150	1500	1500	1500			285	170	8 3/4	7 3/4	34 1/4	20	250	
4 L 6	SA216WCC	SA313Gr.316	900	150		1500	1500	1235		285	170	8 3/4	7 3/4	34 1/4	20	250	
4 L 6	SA216WCC	Inconel	900	150		1500	1500	1235		285	170	8 3/4	7 3/4	34 1/4	20	250	
4 L 6	SA217WC6	Inconel	900	150				1500	650	285	170	8 3/4	7 3/4	34 1/4	20	250	
4 L 6	SA216WCC	Inconel	1500	150		1500	1500	1500		285	170	8 3/4	7 3/4	34 1/4	20	270	
4 L 6	SA216WCC	SA313Gr.316	1500	150		1500	1500	1500		285	170	8 3/4	7 3/4	34 1/4	20	270	
4 L 6	SA217WC6	Inconel	1500	150				1500	1080	600	170	8 3/4	7 3/4	34 1/4	20	270	

Center to face dimensions acc. to API 526. Standard-flange dimensions refer to page 44.

Note

1. Valves set under 15 psig are not ASME code stamped.
2. Maximum I and I1 dimensions +/- 1/16-inch
3. Outlet pressure limit for temperatures above 100°F shall not exceed the rating in ANSI/ASME B16.34

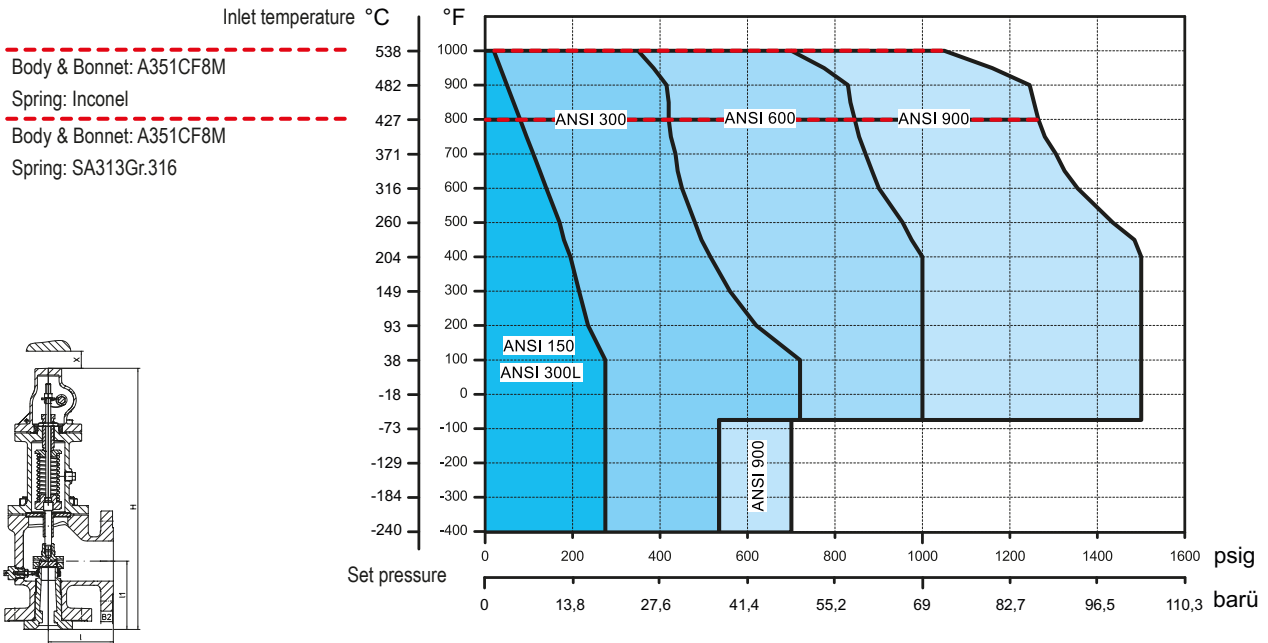

Specifications - Orifice L (effective area acc. to API: 2,853 in²)

Valve size	Material		Flangeconnection ANSI std. (RF or RTJ)		max. pressure rating limit								Dimensions				Weight		
					Inlet flange			Outlet flange	Bellows seal	I	I1	Max. H	Min. X						
					-400°F bis -76°F	-75°F bis -21°F	-20°F bis 100°F							450 °F	550 °F	800 °F		1000 °F	100 °F
inch	Body & Bonnet	Spring	Inlet Class	Outlet Class	psig	psig	psig	psig	psig	psig	psig	psig	psig	psig	inch	inch	inch	inch	lbs
3 L 4	SA351CF8M	SA313Gr.316	150	150	275	275	275	180	155			275	100	6 1/2	6 1/8	26 1/2	14	130	
3 L 4	SA351CF8M	Inconel	150	150					155	80	20	275	100	6 1/2	6 1/8	26 1/2	14	130	
3 L 4	SA351CF8M	SA313Gr.316	300L	150	275	275	275	275	275			275	100	6 1/2	6 1/8	26 1/2	14	140	
3 L 4	SA351CF8M	Inconel	300L	150					275	275	275	275	100	6 1/2	6 1/8	26 1/2	14	140	
4 L 6	SA351CF8M	SA313Gr.316	300	150	535	720	720	495	465			275	170	7 1/8	7 1/16	30 1/4	20	200	
4 L 6	SA351CF8M	Inconel	300	150					465	420	350	275	170	7 1/8	7 1/16	30 1/4	20	200	
4 L 6	SA351CF8M	SA313Gr.316	600	150	535	1000	1000	975	928			275	170	8	7 1/16	30 1/4	20	220	
4 L 6	SA351CF8M	Inconel	600	150					928	835	700	275	170	8	7 1/16	30 1/4	20	220	
4 L 6	SA351CF8M	SA313Gr.316	900	150	700	1500	1500	1485	1395			275	170	8 3/4	7 3/4	34 1/4	20	250	
4 L 6	SA351CF8M	Inconel	900	150					1395	1265	1050	275	170	8 3/4	7 3/4	34 1/4	20	250	

Center to face dimensions acc. to API 526. Standard-flange dimensions refer to page 44.

Note

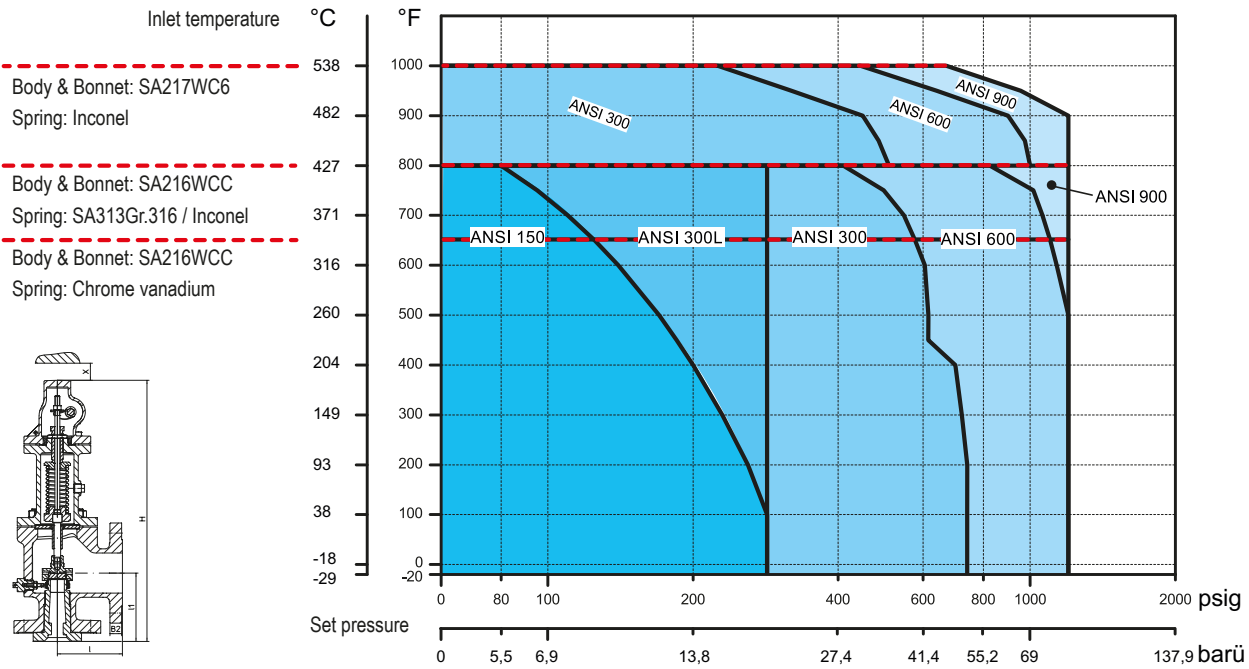
1. Valves set under 15 psig are not ASME code stamped.
2. Maximum I and I1 dimensions +/- 1/16-inch
3. Outlet pressure limit for temperatures above 100°F shall not exceed the rating in ANSI/ASME B16.34



Specifications - Orifice M (effective area acc. to API: 3,60 in²)

Valve size inch	Material		Flangeconnection ANSI std. (RF or RTJ)		max. pressure rating limit								Dimensions				Weight lbs
					Inlet flange					Outlet flange	Bellows seal	I	I1	Max. H	Min. X		
					100°F	450°F	650°F	800°F	1000°F	100°F	100°F						
4 M 6	SA216WCC	Chr. vanad.	150	150	285	185	125				285	80	7 1/4	7	30 1/4	20	190
4 M 6	SA216WCC	SA313Gr.316	150	150		185	125	80			285	80	7 1/4	7	30 1/4	20	190
4 M 6	SA216WCC	Inconel	150	150		185	125	80			285	80	7 1/4	7	30 1/4	20	190
4 M 6	SA216WCC	Chr. vanad.	300L	150	285	285	285				285	80	7 1/4	7	30 1/4	20	200
4 M 6	SA216WCC	SA313Gr.316	300L	150		285	285	285			285	80	7 1/4	7	30 1/4	20	200
4 M 6	SA216WCC	Inconel	300L	150		285	285	285			285	80	7 1/4	7	30 1/4	20	200
4 M 6	SA216WCC	Chr. vanad.	300	150	740	615	590				285	160	7 1/4	7	30 1/4	20	205
4 M 6	SA216WCC	SA313Gr.316	300	150		615	590	410			285	160	7 1/4	7	30 1/4	20	205
4 M 6	SA216WCC	Inconel	300	150		615	590	410			285	160	7 1/4	7	30 1/4	20	205
4 M 6	SA217WC6	Inconel	300	150				510	215		285	160	7 1/4	7	30 1/4	20	205
4 M 6	SA216WCC	Chr. vanad.	600	150	1100	1100	1100				285	160	8	7	33 3/4	20	230
4 M 6	SA216WCC	SA313Gr.316	600	150		1100	1100	825			285	160	8	7	33 3/4	20	230
4 M 6	SA216WCC	Inconel	600	150		1100	1100	825			285	160	8	7	33 3/4	20	230
4 M 6	SA217WC6	Inconel	600	150				1000	430		285	160	8	7	33 3/4	20	230
4 M 6	SA216WCC	Inconel	900	150		1100	1100				285	160	8 3/4	7 3/4	34 1/4	20	260
4 M 6	SA216WCC	SA313Gr.316	900	150		1100	1100	1100	650		285	160	8 3/4	7 3/4	34 1/4	20	260
4 M 6	SA217WC6	Inconel	900	150				1100	650		285	160	8 3/4	7 3/4	34 1/4	20	260

Center to face dimensions acc. to API 526.

Standard-flange dimensions refer to page 44.

Note

1. Valves set under 15 psig are not ASME code stamped.
2. Maximum I and I1 dimensions +/- 1/16-inch
3. Outlet pressure limit for temperatures above 100°F shall not exceed the rating in ANSI/ASME B16.34

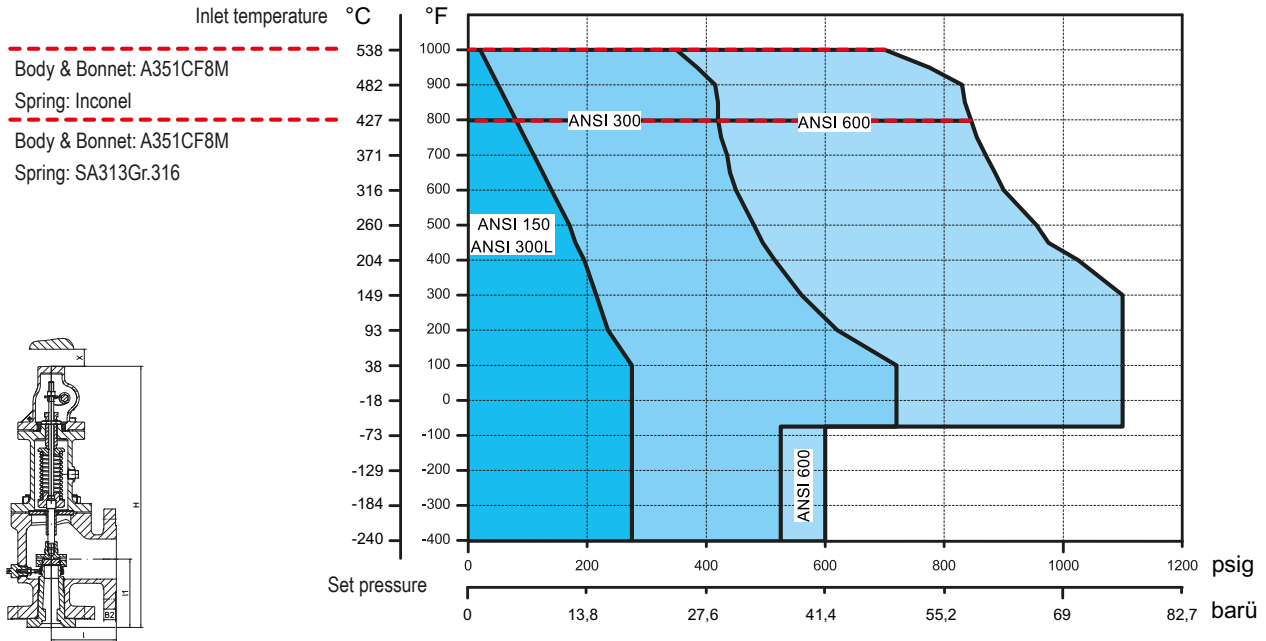

Specifications - Orifice M (effective area acc. to API: 3,60 in²)

Valve size	Material		Flangeconnection ANSI std. (RF or RTJ)		max. pressure rating limit								Dimensions				Weight		
					Inlet flange			Outlet flange	Bellows seal	I	I1	Max. H	Min. X						
					-400°F bis -76°F	-75°F bis -21°F	-20°F bis 100°F							450 °F	550 °F	800 °F		1000 °F	100 °F
inch	Body & Bonnet	Spring	Inlet Class	Outlet Class	psig	psig	psig	psig	psig	psig	psig	psig	psig	psig	inch	inch	inch	inch	lbs
4 M 6	SA351CF8M	SA313Gr.316	150	150	275	275	275	180	155			275	80	7 1/4	7	30 1/4	20	190	
4 M 6	SA351CF8M	Inconel	150	150					155	80	20	275	80	7 1/4	7	30 1/4	20	190	
4 M 6	SA351CF8M	SA313Gr.316	300L	150	275	275	275	275	275			275	160	7 1/4	7	30 1/4	20	200	
4 M 6	SA351CF8M	Inconel	300L	150					275	275	275	275	160	7 1/4	7	30 1/4	20	200	
4 M 6	SA351CF8M	SA313Gr.316	300	150	525	720	720	495	465			275	160	7 1/4	7	30 1/4	20	205	
4 M 6	SA351CF8M	Inconel	300	150					465	420	350	275	160	7 1/4	7	30 1/4	20	205	
4 M 6	SA351CF8M	SA313Gr.316	600	150	600	1100	1100	975	928			275	160	8	7	33 3/4	20	230	
4 M 6	SA351CF8M	Inconel	600	150					928	845	700	275	160	8	7	33 3/4	20	230	

Center to face dimensions acc. to API 526. Standard-flange dimensions refer to page 44.

Note

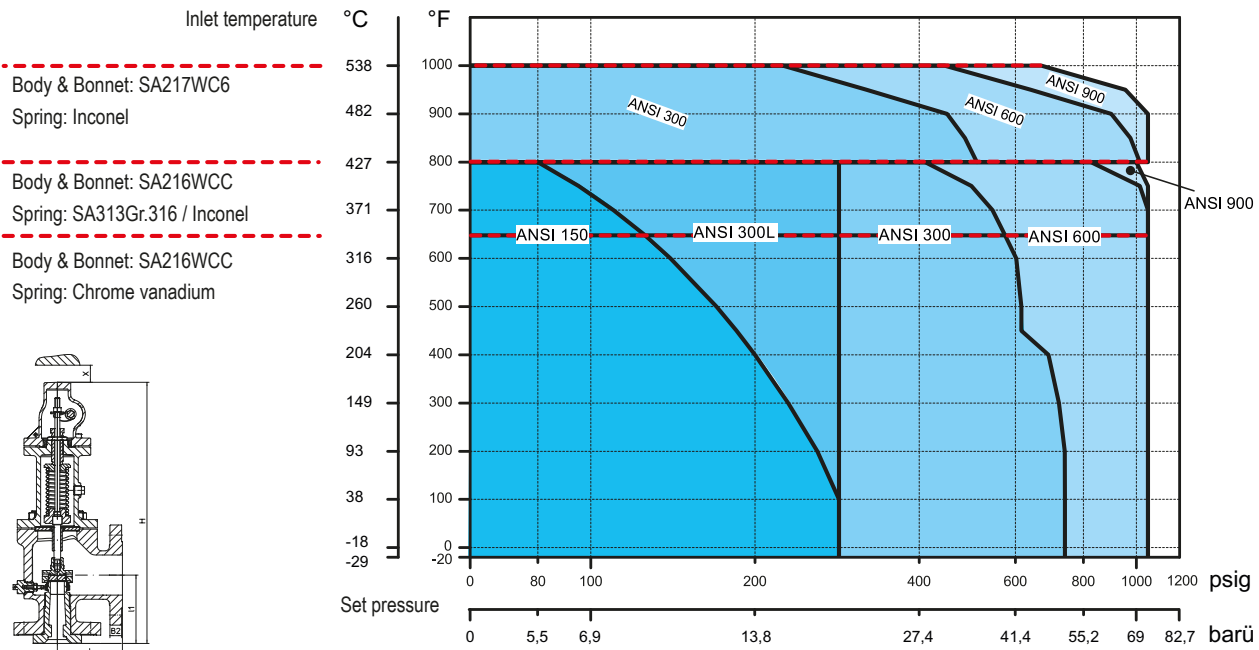
1. Valves set under 15 psig are not ASME code stamped.
2. Maximum I and I1 dimensions +/- 1/16-inch
3. Outlet pressure limit for temperatures above 100°F shall not exceed the rating in ANSI/ASME B16.34

Specifications - Orifice N (effective area acc. to API: 4,34 in²)

Valve size	Material		Flangeconnection ANSI std. (RF or RTJ)		max. pressure rating limit							Dimensions				Weight
					Inlet flange					Outlet flange	Bellows seal	I	I1	Max. H	Min. X	
					100°F	450°F	650°F	800°F	1000°F	100°F	100°F	inch	inch	inch	inch	
inch	Body & Bonnet	Spring	Inlet Class	Outlet Class	psig	psig	psig	psig	psig	psig	psig	inch	inch	inch	inch	lbs
4 N 6	SA216WCC	Chr. vanad.	150	150	285	185	125			285	80	8 1/4	7 3/4	31 1/2	20	200
4 N 6	SA216WCC	SA313Gr.316	150	150		185	125	80		285	80	8 1/4	7 3/4	31 1/2	20	200
4 N 6	SA216WCC	Inconel	150	150		185	125	80		285	80	8 1/4	7 3/4	31 1/2	20	200
4 N 6	SA216WCC	Chr. vanad.	300L	150	285	285	285			285	160	8 1/4	7 3/4	31 1/2	20	200
4 N 6	SA216WCC	SA313Gr.316	300L	150		285	285	285		285	160	8 1/4	7 3/4	31 1/2	20	200
4 N 6	SA216WCC	Inconel	300L	150		285	285	285		285	160	8 1/4	7 3/4	31 1/2	20	200
4 N 6	SA216WCC	Chr. vanad.	300	150	740	615	590			285	160	8 1/4	7 3/4	35	20	230
4 N 6	SA216WCC	SA313Gr.316	300	150		615	590	410		285	160	8 1/4	7 3/4	35	20	230
4 N 6	SA216WCC	Inconel	300	150		615	590	410		285	160	8 1/4	7 3/4	35	20	230
4 N 6	SA217WC6	Inconel	300	150				510	215	285	160	8 1/4	7 3/4	31 1/2	20	215
4 N 6	SA216WCC	Chr. vanad.	600	150	1000	1000	1000			285	160	8 3/4	7 3/4	35	20	250
4 N 6	SA216WCC	SA313Gr.316	600	150		1000	1000	825		285	160	8 3/4	7 3/4	35	20	250
4 N 6	SA216WCC	Inconel	600	150		1000	1000	825		285	160	8 3/4	7 3/4	35	20	250
4 N 6	SA217WC6	Inconel	600	150				1000	430	285	160	8 3/4	7 3/4	35	20	250
4 N 6	SA216WCC	Inconel	900	150		1000	1000	1000		285	160	8 3/4	7 3/4	35	20	270
4 N 6	SA217WC6	SA313Gr.316	900	150		1000	1000	1000		285	160	8 3/4	7 3/4	35	20	270
4 N 6	SA217WC6	Inconel	900	150				1000	650	285	160	8 3/4	7 3/4	35	20	270

Center to face dimensions acc. to API 526.

Standard-flange dimensions refer to page 44.

Note

1. Valves set under 15 psig are not ASME code stamped.
2. Maximum I and I1 dimensions +/- 1/16-inch
3. Outlet pressure limit for temperatures above 100°F shall not exceed the rating in ANSI/ASME B16.34

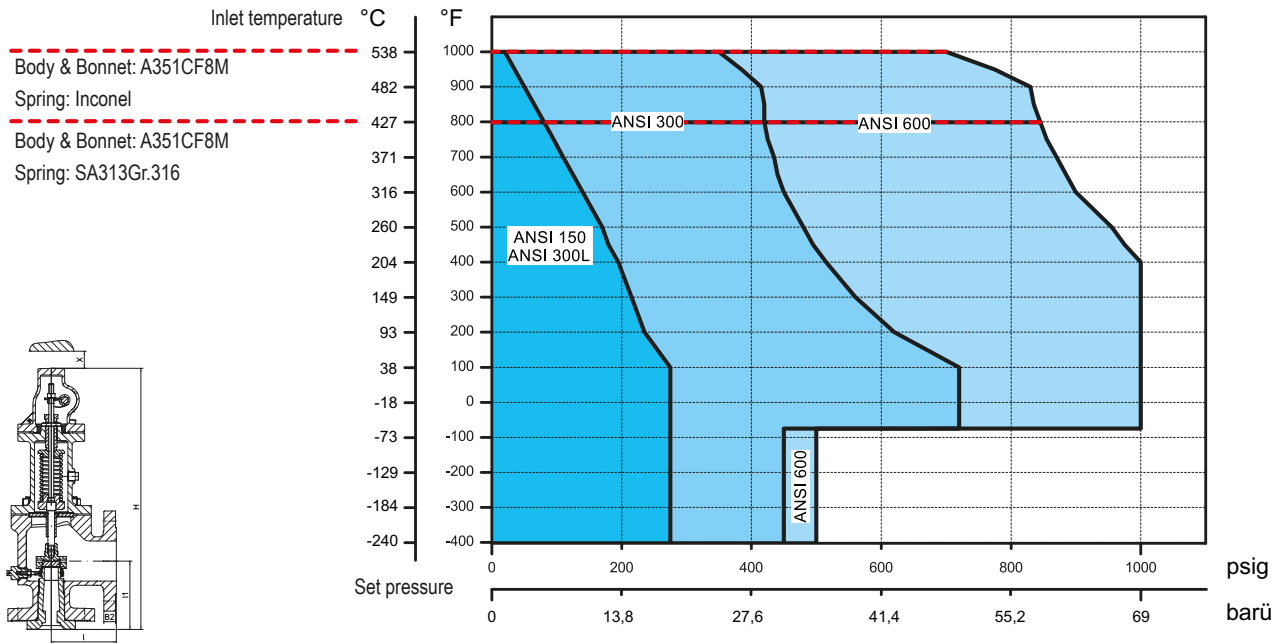

Specifications - Orifice N (effective area acc. to API: 4,34 in²)

Valve size	Material		Flangeconnection ANSI std. (RF or RTJ)		max. pressure rating limit								Dimensions				Weight		
					Inlet flange			Outlet flange	Bellows seal	I	I1	Max. H	Min. X						
					-400°F bis -76°F	-75°F bis -21°F	-20°F bis 100°F							450 °F	550 °F	800 °F		1000 °F	100 °F
inch	Body & Bonnet	Spring	Inlet Class	Outlet Class	psig	psig	psig	psig	psig	psig	psig	psig	psig	psig	inch	inch	inch	inch	lbs
4 N 6	SA351CF8M	SA313Gr.316	150	150	275	275	275	180	155			275	80	8 1/4	7 3/4	31 1/2	20	200	
4 N 6	SA351CF8M	Inconel	150	150					155	80	20	275	80	8 1/4	7 3/4	31 1/2	20	200	
4 N 6	SA351CF8M	SA313Gr.316	300L	150	275	275	275	275	275			275	160	8 1/4	7 3/4	31 1/2	20	200	
4 N 6	SA351CF8M	Inconel	300L	150					275	275	275	275	160	8 1/4	7 3/4	31 1/2	20	200	
4 N 6	SA351CF8M	SA313Gr.316	300	150	450	720	720	495	465			275	160	8 1/4	7 3/4	35	20	230	
4 N 6	SA351CF8M	Inconel	300	150					465	420	350	275	160	8 1/4	7 3/4	35	20	230	
4 N 6	SA351CF8M	SA313Gr.316	600	150	500	1000	1000	975	928			275	160	8 3/4	7 3/4	35	20	250	
4 N 6	SA351CF8M	Inconel	600	150					928	845	700	275	160	8 3/4	7 3/4	35	20	250	

Center to face dimensions acc. to API 526. Standard-flange dimensions refer to page 44.

Note

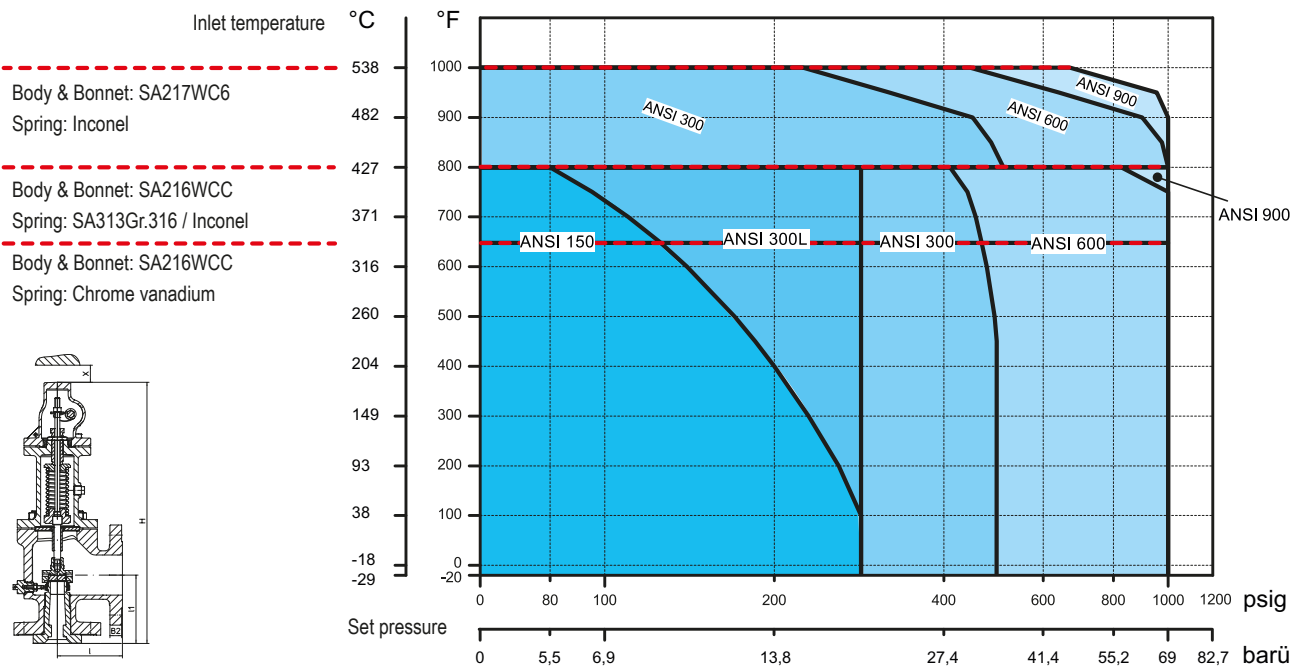
1. Valves set under 15 psig are not ASME code stamped.
2. Maximum I and I1 dimensions +/- 1/16-inch
3. Outlet pressure limit for temperatures above 100°F shall not exceed the rating in ANSI/ASME B16.34

Specifications - Orifice P (effective area acc. to API: 6,38 in²)

Valve size	Material		Flangeconnection ANSI std. (RF or RTJ)		max. pressure rating limit							Dimensions				Weight
					Inlet flange					Outlet flange	Bellows seal	I	I1	Max. H	Min. X	
					100°F	450°F	650°F	800°F	1000°F	100°F	100°F	inch	inch	inch	inch	
inch	Body & Bonnet	Spring	Inlet Class	Outlet Class	psig	psig	psig	psig	psig	psig	psig	inch	inch	inch	inch	lbs
4 P 6	SA216WCC	Chr. vanad.	150	150	285	185	125			285	80	9	7 1/8	30 7/8	20	210
4 P 6	SA216WCC	SA313Gr.316	150	150		185	125	80		285	80	9	7 1/8	30 7/8	20	210
4 P 6	SA216WCC	Inconel	150	150		185	125	80		285	80	9	7 1/8	30 7/8	20	210
4 P 6	SA216WCC	Chr. vanad.	300L	150	285	285	285			285	80	9	7 1/8	30 7/8	20	220
4 P 6	SA216WCC	SA313Gr.316	300L	150		285	285	285		285	80	9	7 1/8	30 7/8	20	220
4 P 6	SA216WCC	Inconel	300L	150		285	285	285		285	80	9	7 1/8	30 7/8	20	220
4 P 6	SA216WCC	Chr. vanad.	300	150	525	525	525			285	150	10	8 7/8	42 1/2	20	330
4 P 6	SA216WCC	SA313Gr.316	300	150		525	525	410		285	150	10	8 7/8	42 1/2	20	330
4 P 6	SA216WCC	Inconel	300	150		525	525	410		285	150	10	8 7/8	42 1/2	20	330
4 P 6	SA217WC6	Inconel	300	150				510	215	285	160	10	8 7/8	42 1/2	20	330
4 P 6	SA216WCC	Chr. vanad.	600	150	1000	1000	1000			285	150	10	8 7/8	42 1/2	20	360
4 P 6	SA216WCC	SA313Gr.316	600	150		1000	1000	825		285	150	10	8 7/8	42 1/2	20	360
4 P 6	SA216WCC	Inconel	600	150		1000	1000	825		285	150	10	8 7/8	42 1/2	20	360
4 P 6	SA217WC6	Inconel	600	150				1000	430	285	160	10	8 7/8	42 1/2	20	360
4 P 6	SA216WCC	SA313Gr.316	900	150		1000	1000	1000		285	150	10	8 7/8	42 1/2	20	380
4 P 6	SA216WCC	Inconel	900	150		1000	1000	1000		285	150	10	8 7/8	42 1/2	20	380
4 P 6	SA217WC6	Inconel	900	150				1000	650	285	160	10	8 7/8	42 1/2	20	380

Center to face dimensions acc. to API 526.

Standard-flange dimensions refer to page 44.

Note

1. Valves set under 15 psig are not ASME code stamped.
2. Maximum I and I1 dimensions +/- 1/16-inch
3. Outlet pressure limit for temperatures above 100°F shall not exceed the rating in ANSI/ASME B16.34

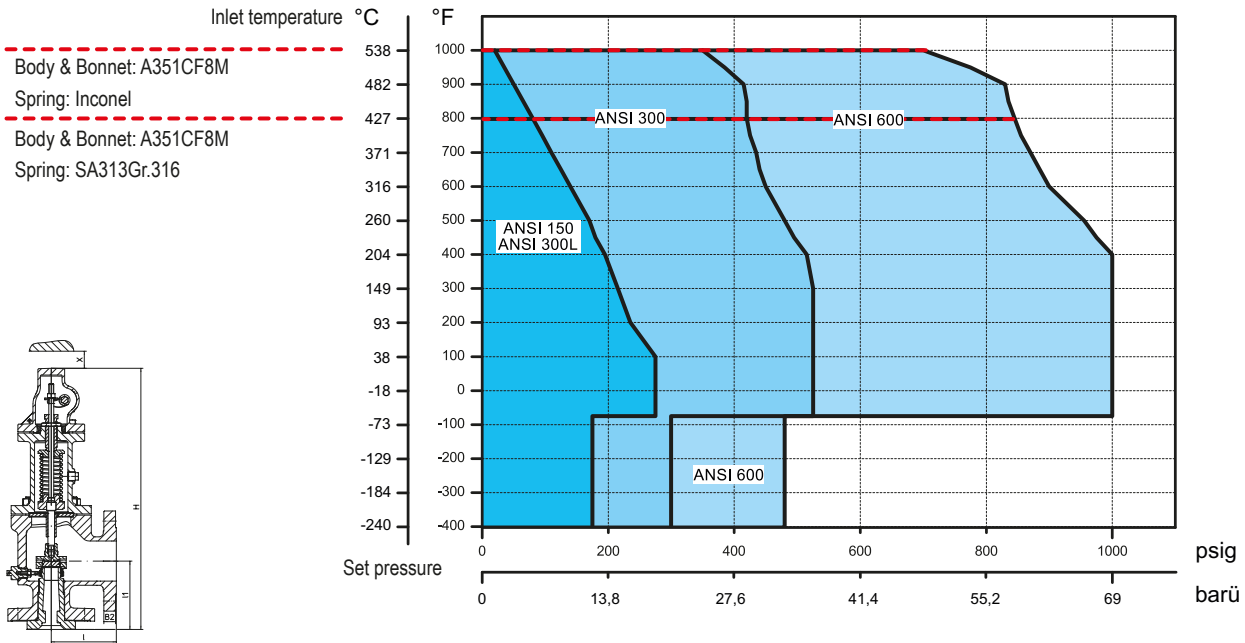

Specifications - Orifice P (effective area acc. to API: 6,38 in²)

Valve size	Material		Flangeconnection ANSI std. (RF or RTJ)		max. pressure rating limit								Dimensions				Weight		
					Inlet flange			Outlet flange	Bellows seal	I	I1	Max. H	Min. X						
					-400°F bis -76°F	-75°F bis -21°F	-20°F bis 100°F							450 °F	550 °F	800 °F		1000 °F	100 °F
inch	Body & Bonnet	Spring	Inlet Class	Outlet Class	psig	psig	psig	psig	psig	psig	psig	psig	psig	psig	inch	inch	inch	inch	lbs
4 P 6	SA351CF8M	SA313Gr.316	150	150	275	275	275	180	155			275	80	9	7 1/8	30 7/8	20	210	
4 P 6	SA351CF8M	Inconel	150	150					155	80	20	275	80	9	7 1/8	30 7/8	20	210	
4 P 6	SA351CF8M	SA313Gr.316	300L	150	275	275	275	275	275			275	160	9	7 1/8	30 7/8	20	220	
4 P 6	SA351CF8M	Inconel	300L	150					275	275	275	275	160	9	7 1/8	30 7/8	20	220	
4 P 6	SA351CF8M	SA313Gr.316	300	150	300	525	525	495	465			275	160	10	8 7/8	42 1/2	20	330	
4 P 6	SA351CF8M	Inconel	300	150					465	420	350	275	160	10	8 7/8	42 1/2	20	330	
4 P 6	SA351CF8M	SA313Gr.316	600	150	480	1000	1000	975	928			275	160	10	8 7/8	42 1/2	20	360	
4 P 6	SA351CF8M	Inconel	600	150					928	845	700	275	160	10	8 7/8	42 1/2	20	360	

Center to face dimensions acc. to API 526. Standard-flange dimensions refer to page 44.

Note

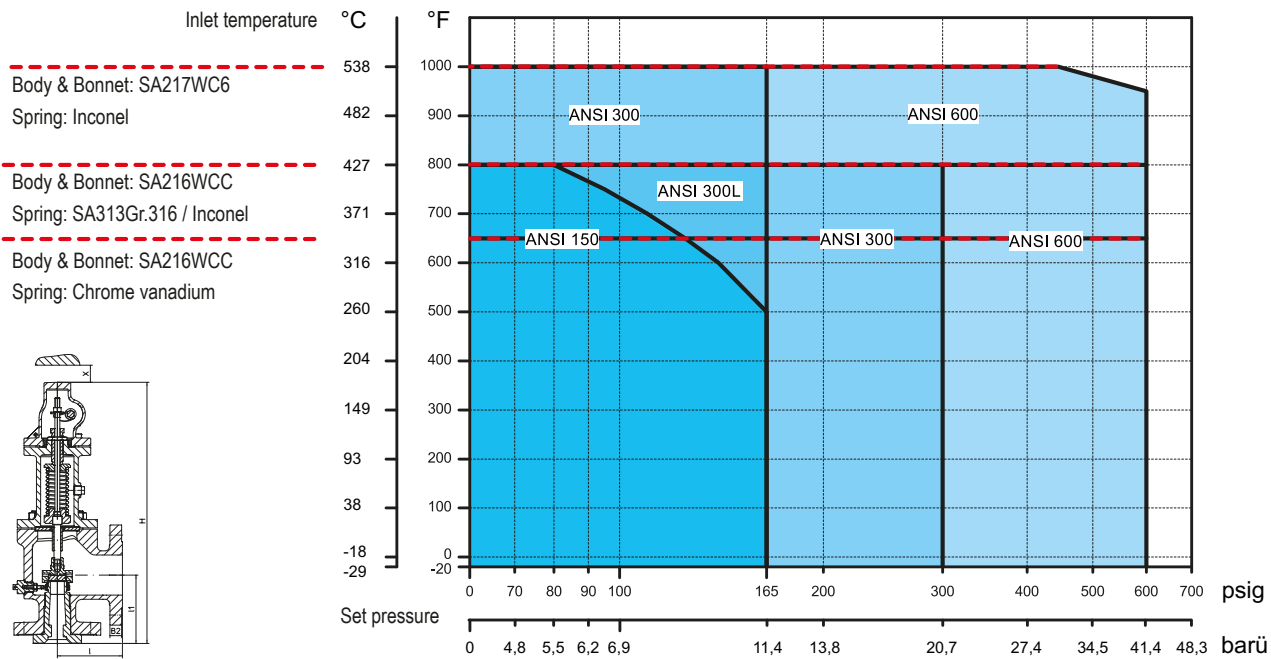
1. Valves set under 15 psig are not ASME code stamped.
2. Maximum I and I1 dimensions +/- 1/16-inch
3. Outlet pressure limit for temperatures above 100°F shall not exceed the rating in ANSI/ASME B16.34

Specifications - Orifice Q (effective area acc. to API: 11,05 in²)

Valve size	Material		Flangeconnection ANSI std. (RF or RTJ)		max. pressure rating limit							Dimensions				Weight	
					Inlet flange					Outlet flange	Bellows seal	I	I1	Max. H	Min. X		
					100°F	450°F	650°F	800°F	1000°F	100°F	100°F	inch	inch	inch	inch		
inch	Body & Bonnet	Spring	Inlet Class	Outlet Class	psig	psig	psig	psig	psig	psig	psig	inch	inch	inch	inch	lbs	
6 Q 8	SA216WCC	Chr. vanad.	150	150	165	165	125				115	70	9 1/2	9 7/16	45 1/2	20	480
6 Q 8	SA216WCC	SA313Gr.316	150	150		165	125	80			115	70	9 1/2	9 7/16	45 1/2	20	480
6 Q 8	SA216WCC	Inconel	150	150		165	125	80			115	70	9 1/2	9 7/16	45 1/2	20	480
6 Q 8	SA216WCC	Chr. vanad.	300L	150	165	165	165				115	70	9 1/2	9 7/16	45 1/2	20	500
6 Q 8	SA216WCC	SA313Gr.316	300L	150		165	165	165			115	70	9 1/2	9 7/16	45 1/2	20	500
6 Q 8	SA216WCC	Inconel	300L	150		165	165	165			115	70	9 1/2	9 7/16	45 1/2	20	500
6 Q 8	SA216WCC	Chr. vanad.	300	150	300	300	300				115	115	9 1/2	9 7/16	45 1/2	20	520
6 Q 8	SA216WCC	SA313Gr.316	300	150		300	300	300			115	115	9 1/2	9 7/16	45 1/2	20	520
6 Q 8	SA216WCC	Inconel	300	150		300	300	300			115	115	9 1/2	9 7/16	45 1/2	20	520
6 Q 8	SA217WC6	Inconel	300	150		300		165	165		115	115	9 1/2	9 7/16	45 1/2	20	520
6 Q 8	SA216WCC	Chr. vanad.	600	150	600	600	600				115	115	9 1/2	9 7/16	49 1/2	20	630
6 Q 8	SA216WCC	SA313Gr.316	600	150		600	600	600			115	115	9 1/2	9 7/16	49 1/2	20	630
6 Q 8	SA216WCC	Inconel	600	150		600	600	600			115	115	9 1/2	9 7/16	49 1/2	20	630
6 Q 8	SA217WC6	Inconel	600	150				600	430		115	115	9 1/2	9 7/16	49 1/2	20	630

Center to face dimensions acc. to API 526.

Standard-flange dimensions refer to page 44.

Note

1. Valves set under 15 psig are not ASME code stamped.
2. Maximum I and I1 dimensions +/- 1/8-inch
3. Outlet pressure limit for temperatures above 100°F shall not exceed the rating in ANSI/ASME B16.34

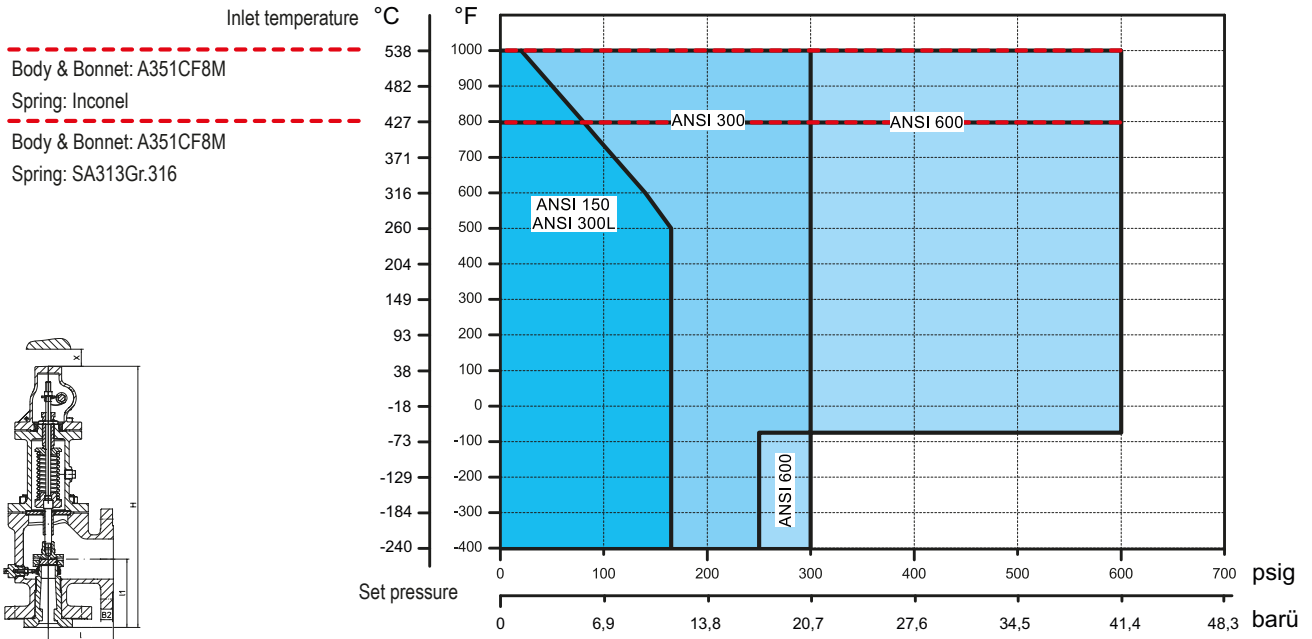

Specifications - Orifice Q (effective area acc. to API: 11,05 in²)

Valve size	Material		Flangeconnection ANSI std. (RF or RTJ)		max. pressure rating limit								Dimensions				Weight		
					Inlet flange			Outlet flange	Bellows seal	I	I1	Max. H	Min. X						
					-400°F bis -76°F	-75°F bis -21°F	-20°F bis 100°F							450 °F	550 °F	800 °F		1000 °F	100 °F
inch	Body & Bonnet	Spring	Inlet Class	Outlet Class	psig	psig	psig	psig	psig	psig	psig	psig	psig	psig	inch	inch	inch	inch	lbs
6 Q 8	SA351CF8M	SA313Gr.316	150	150	165	165	165	165	153			115	70	9 1/2	9 7/16	45 1/2	20	480	
6 Q 8	SA351CF8M	Inconel	150	150					153	80	20	115	70	9 1/2	9 7/16	45 1/2	20	480	
6 Q 8	SA351CF8M	SA313Gr.316	300L	150	165	165	165	165	165			115	115	9 1/2	9 7/16	45 1/2	20	500	
6 Q 8	SA351CF8M	Inconel	300L	150					165	165	165	115	115	9 1/2	9 7/16	45 1/2	20	500	
6 Q 8	SA351CF8M	SA313Gr.316	300	150	250	300	300	300	300			115	115	9 1/2	9 7/16	45 1/2	20	520	
6 Q 8	SA351CF8M	Inconel	300	150					300	300	300	115	115	9 1/2	9 7/16	45 1/2	20	520	
6 Q 8	SA351CF8M	SA313Gr.316	600	150	300	600	600	600	600			115	115	9 1/2	9 7/16	49 1/2	20	630	
6 Q 8	SA351CF8M	Inconel	600	150					600	600	600	115	115	9 1/2	9 7/16	49 1/2	20	630	

Center to face dimensions acc. to API 526. Standard-flange dimensions refer to page 44.

Note

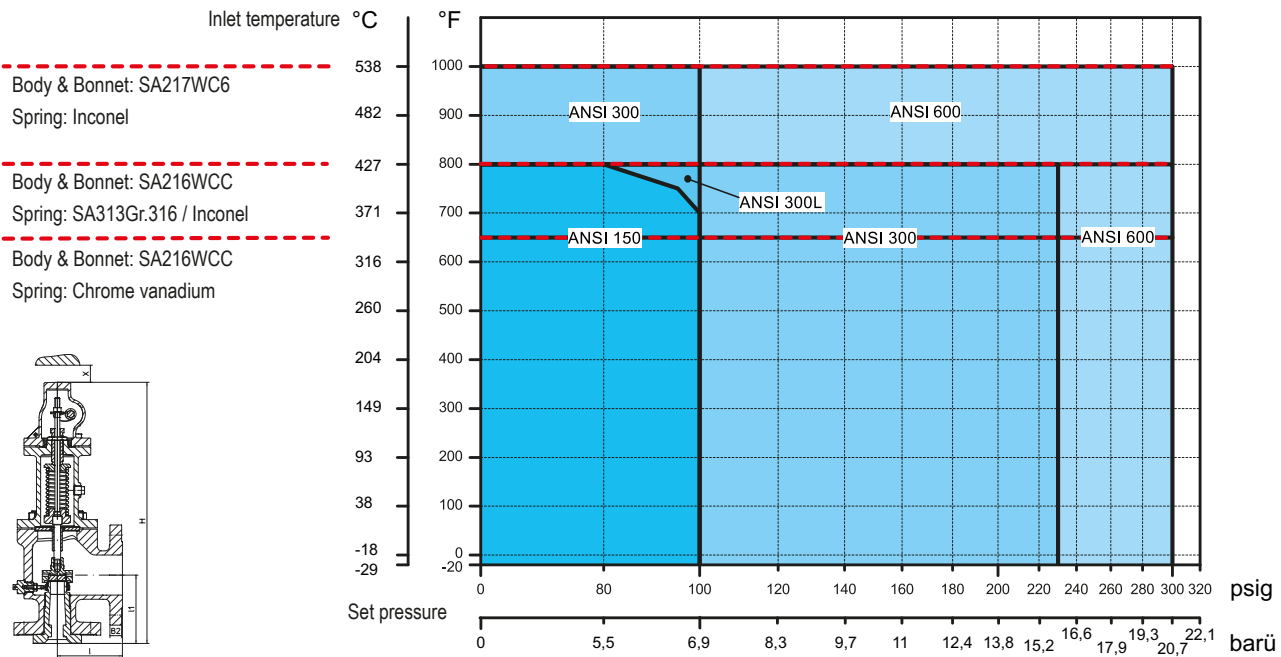
1. Valves set under 15 psig are not ASME code stamped.
2. Maximum I and I1 dimensions +/- 1/8-inch
3. Outlet pressure limit for temperatures above 100°F shall not exceed the rating in ANSI/ASME B16.34



Specifications - Orifice R (effective area acc. to API: 16,00 in²)

Valve size	Material		Flangeconnection ANSI std. (RF or RTJ)		max. pressure rating limit								Dimensions				Weight
					Inlet flange					Outlet flange	Bellows seal	I	I1	Max. H	Min. X		
					100°F	450°F	650°F	800°F	1000°F	100°F	100°F						
inch	Body & Bonnet	Spring	Inlet Class	Outlet Class	psig	psig	psig	psig	psig	psig	psig	psig	inch	inch	inch	inch	lbs
6 R 8	SA216WCC	Chr. vanad.	150	150	100	100	65				60	60	9 1/2	9 7/16	45 1/2	20	500
6 R 8	SA216WCC	SA313Gr.316	150	150		100	65	80			60	60	9 1/2	9 7/16	45 1/2	20	500
6 R 8	SA216WCC	Inconel	150	150		100	65	80			60	60	9 1/2	9 7/16	45 1/2	20	500
6 R 8	SA216WCC	Chr. vanad.	300L	150	100	100	100				60	60	9 1/2	9 7/16	45 1/2	20	520
6 R 8	SA216WCC	SA313Gr.316	300L	150		100	100	100			60	60	9 1/2	9 7/16	45 1/2	20	520
6 R 8	SA216WCC	Inconel	300L	150		100	100	100			60	60	9 1/2	9 7/16	45 1/2	20	520
6 R 10	SA216WCC	Chr. vanad.	300	150	230	230	230				100	100	10 1/2	9 7/16	45 1/2	20	620
6 R 10	SA216WCC	SA313Gr.316	300	150		230	230	230			100	100	10 1/2	9 7/16	45 1/2	20	620
6 R 10	SA216WCC	Inconel	300	150		230	230	230			100	100	10 1/2	9 7/16	45 1/2	20	620
6 R 10	SA217WC6	Inconel	300	150				100	100		100	100	9 1/2	9 7/16	45 1/2	20	520
6 R 10	SA216WCC	Chr. vanad.	600	150	300	300	300				100	100	10 1/2	9 7/16	49 1/2	20	660
6 R 10	SA216WCC	SA313Gr.316	600	150		300	300	300			100	100	10 1/2	9 7/16	49 1/2	20	660
6 R 10	SA216WCC	Inconel	600	150		300	300	300			100	100	10 1/2	9 7/16	49 1/2	20	660
6 R 10	SA217WC6	Inconel	600	150				300	300		100	100	10 1/2	9 7/16	49 1/2	20	660

Center to face dimensions acc. to API 526. Standard-flange dimensions refer to page 44.

Note

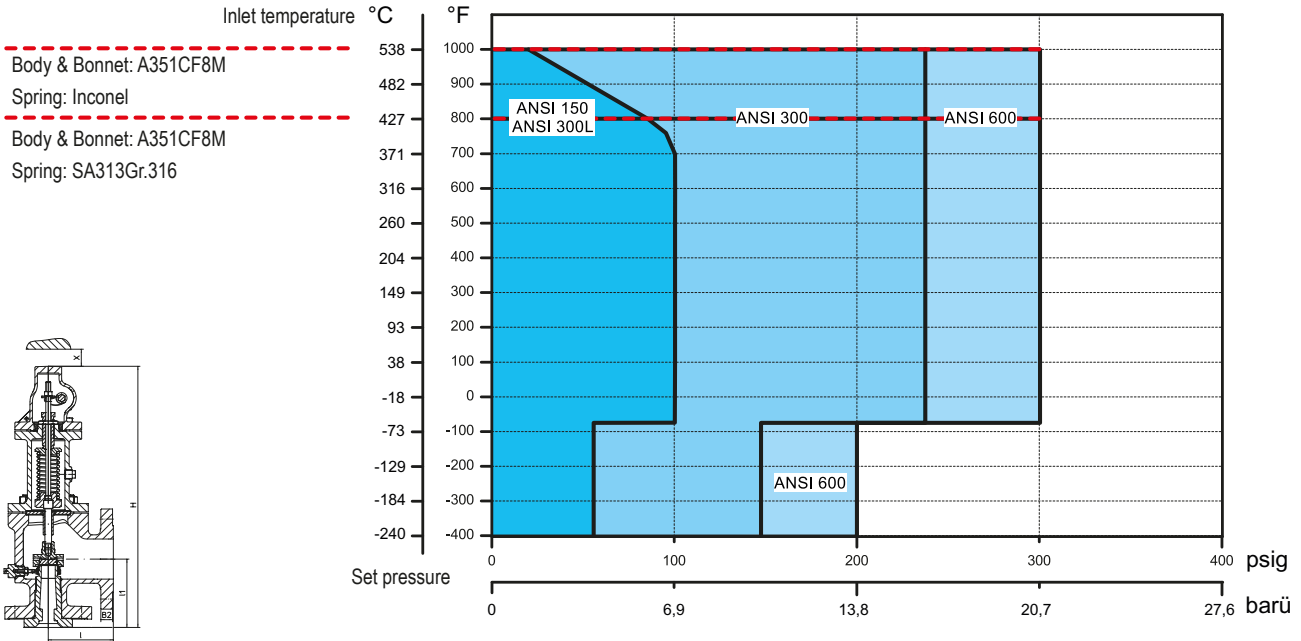
1. Valves set under 15 psig are not ASME code stamped.
2. Maximum I and I1 dimensions +/- 1/8-inch
3. Outlet pressure limit for temperatures above 100°F shall not exceed the rating in ANSI/ASME B16.34



Specifications - Orifice R (effective area acc. to API: 16,00 in²)

Valve size	Material		Flangeconnection ANSI std. (RF or RTJ)		max. pressure rating limit								Dimensions				Weight		
					Inlet flange			Outlet flange	Bellows seal	I	I1	Max. H	Min. X						
					-400°F bis -76°F	-75°F bis -21°F	-20°F bis 100°F							450 °F	550 °F	800 °F		1000 °F	100 °F
inch	Body & Bonnet	Spring	Inlet Class	Outlet Class	psig	psig	psig	psig	psig	psig	psig	psig	psig	psig	inch	inch	inch	inch	lbs
6 R 8	SA351CF8M	SA313Gr.316	150	150	55	100	100	100	100				60	60	9 1/2	9 7/16	45 1/2	20	500
6 R 8	SA351CF8M	Inconel	150	150					100	80	20	60	60	9 1/2	9 7/16	45 1/2	20	500	
6 R 8	SA351CF8M	SA313Gr.316	300L	150	55	100	100	100	100				60	100	9 1/2	9 7/16	45 1/2	20	520
6 R 8	SA351CF8M	Inconel	300L	150					100	100	100	60	100	9 1/2	9 7/16	45 1/2	20	520	
6 R 10	SA351CF8M	SA313Gr.316	300	150	150	230	230	230	230				100	100	10 1/2	9 7/16	45 1/2	20	620
6 R 10	SA351CF8M	Inconel	300	150					230	230	230	100	100	10 1/2	9 7/16	45 1/2	20	620	
6 R 10	SA351CF8M	SA313Gr.316	600	150	200	300	300	300	300				100	100	10 1/2	9 7/16	49 1/2	20	660
6 R 10	SA351CF8M	Inconel	600	150					300	300	300	100	100	10 1/2	9 7/16	49 1/2	20	660	

Center to face dimensions acc. to API 526. Standard-flange dimensions refer to page 44.

Note

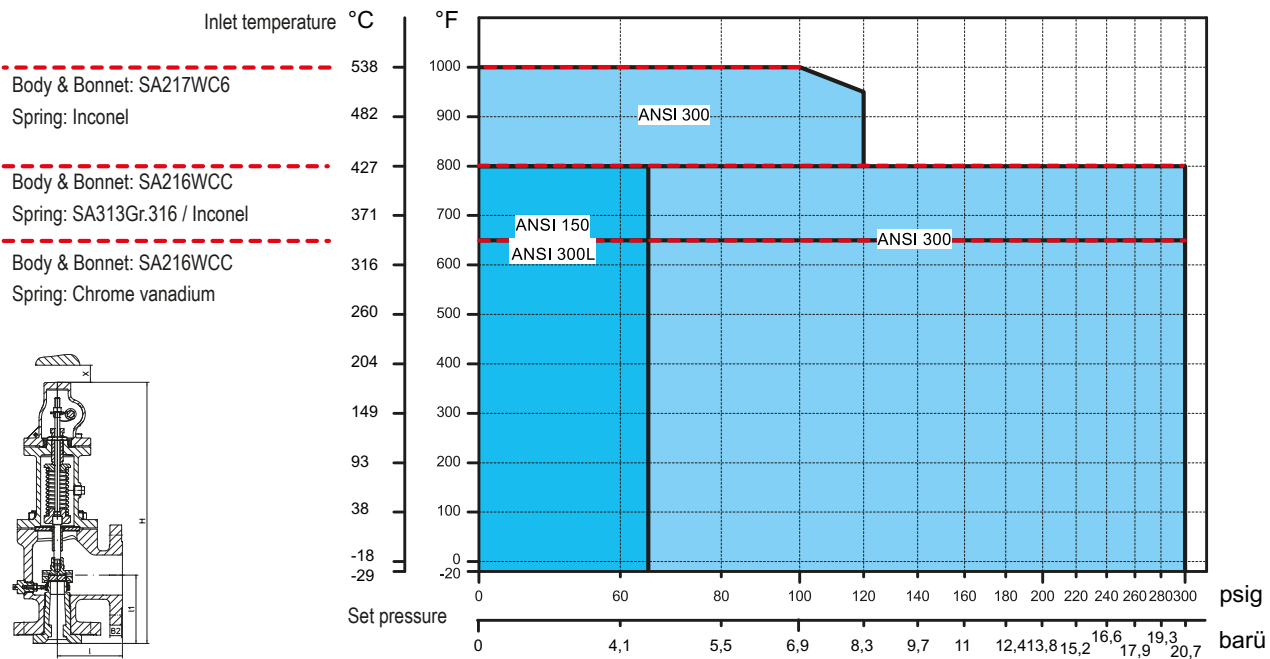
- Valves set under 15 psig are not ASME code stamped.
- Maximum I and I1 dimensions +/- 1/8-inch
- Outlet pressure limit for temperatures above 100°F shall not exceed the rating in ANSI/ASME B16.34

Specifications - Orifice T (effective area acc. to API: 26,00 in²)

Valve size	Material		Flangeconnection ANSI std. (RF or RTJ)		max. pressure rating limit								Dimensions				Weight
					Inlet flange					Outlet flange	Bellows seal	I	I1	Max. H	Min. X		
					100°F	450°F	650°F	800°F	1000°F	100°F	100°F	inch	inch	inch	inch		
inch	Body & Bonnet	Spring	Inlet Class	Outlet Class	psig	psig	psig	psig	psig	psig	psig	inch	inch	inch	inch	lbs	
8 T 10	SA216WCC	Chr. vanad.	150	150	65	65	65				30	30	11	10 7/8	47 3/4	30	670
8 T 10	SA216WCC	SA313Gr.316	150	150		65	65	65			30	30	11	10 7/8	47 3/4	30	670
8 T 10	SA216WCC	Inconel	150	150		65	65	65			30	30	11	10 7/8	47 3/4	30	670
8 T 10	SA216WCC	Chr. vanad.	300L	150	65	65	65				30	30	11	10 7/8	47 3/4	30	700
8 T 10	SA216WCC	SA313Gr.316	300L	150		65	65	65			30	30	11	10 7/8	47 3/4	30	700
8 T 10	SA216WCC	Inconel	300L	150		65	65	65			30	30	11	10 7/8	47 3/4	30	700
8 T 10	SA216WCC	Chr. vanad.	300	150	300	300	300				60	60	11	10 7/8	54 3/4	30	830
8 T 10	SA216WCC	SA313Gr.316	300	150		300	300	300			60	60	11	10 7/8	54 3/4	30	830
8 T 10	SA216WCC	Inconel	300	150		300	300	300			60	60	11	10 7/8	54 3/4	30	830
8 T 10	SA217WC6	Inconel	300	150				120	100		60	60	11	10 7/8	51 1/2	30	790

Center to face dimensions acc. to API 526.

Standard-flange dimensions refer to page 44.

Note

1. Valves set under 15 psig are not ASME code stamped.
2. Maximum I and I1 dimensions +/- 1/8-inch
3. Outlet pressure limit for temperatures above 100°F shall not exceed the rating in ANSI/ASME B16.34

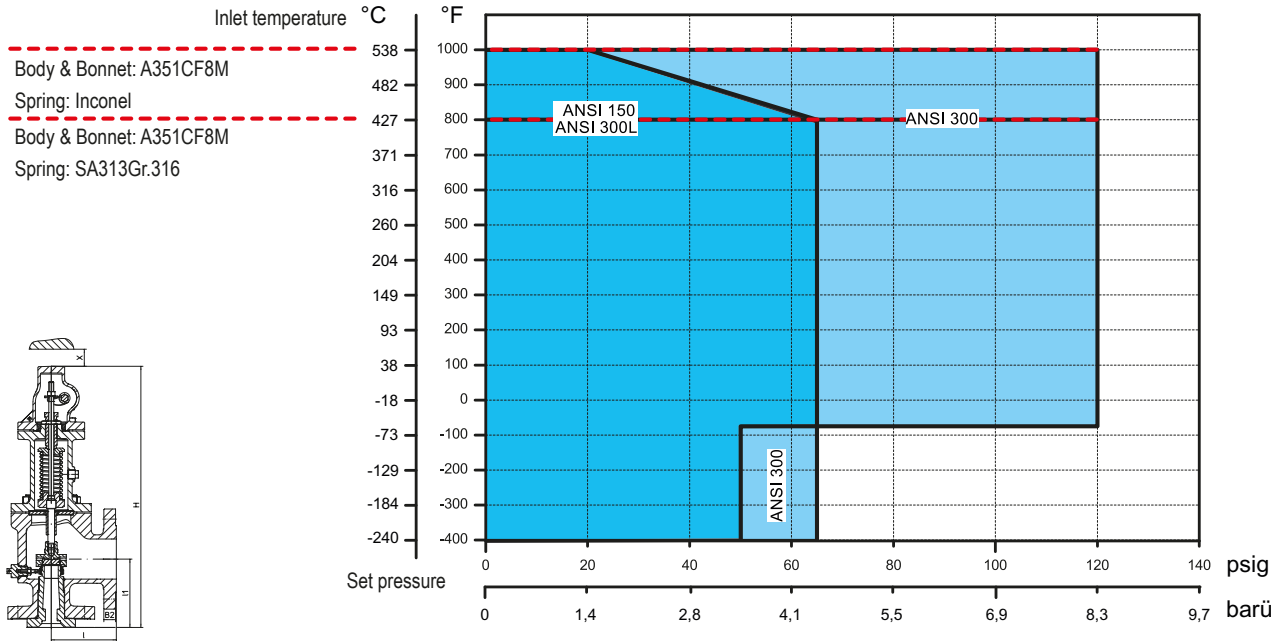
Specifications - Orifice T (effective area acc. to API: 26,00 in²)

Valve size	Material		Flangeconnection ANSI std. (RF or RTJ)		max. pressure rating limit								Dimensions				Weight	
					Inlet flange			Outlet flange	Bellows seal	I	I1	Max. H	Min. X					
					-400°F bis -76°F	-75°F bis -21°F	-20°F bis 100°F							450 °F	550 °F	800 °F		1000 °F
inch	Body & Bonnet	Spring	Inlet Class	Outlet Class	psig	psig	psig	psig	psig	psig	psig	psig	psig	inch	inch	inch	inch	lbs
8 T 10	SA351CF8M	SA313Gr.316	150	150	50	65	65	65	65			30	30	11	10 7/8	47 3/4	30	670
8 T 10	SA351CF8M	Inconel	150	150					65	65	20	30	30	11	10 7/8	47 3/4	30	670
8 T 10	SA351CF8M	SA313Gr.316	300L	150	50	65	65	65	65			30	60	11	10 7/8	47 3/4	30	700
8 T 10	SA351CF8M	Inconel	300L	150					65	65	65	30	60	11	10 7/8	47 3/4	30	700
8 T 10	SA351CF8M	SA313Gr.316	300	150	65	120	120	120	120			60	60	11	10 7/8	51 1/2	30	790
8 T 10	SA351CF8M	Inconel	300	150					120	120	120	60	60	11	10 7/8	51 1/2	30	790

Center to face dimensions acc. to API 526. Standard-flange dimensions refer to page 44.

Note

1. Valves set under 15 psig are not ASME code stamped.
2. Maximum I and I1 dimensions +/- 1/8-inch
3. Outlet pressure limit for temperatures above 100°F shall not exceed the rating in ANSI/ASME B16.34

Coeff. of discharge: 0,860		Orifice								
		D	E	F	G	H	J	K	L	
Design area [A ₀]		0,122 in ²	0,217 in ²	0,34 in ²	0,558 in ²	0,869 in ²	1,427 in ²	2,036 in ²	3,16 in ²	
Design diameter [d ₀]		0,394 in	0,526 in	0,658 in	0,843 in	1,052 in	1,348 in	1,61 in	2,006 in	
Set pressure [psig]										
< 30 psig with + 3 psig overpressure	5	on request								
	10	on request								
	No Code Stamp or NB on Nameplates Below 15 psig									
	15	63	112	175	288	448	736	1050	1629	
	20	72	129	202	332	516	848	1210	1878	
	30	92	163	256	420	653	1073	1531	2376	
40	113	201	315	516	804	1321	1884	2924		
50	134	239	374	613	955	1568	2237	3472		
60	155	276	433	710	1106	1815	2590	4020		
70	176	314	492	807	1256	2063	2943	4568		
80	197	352	550	903	1407	2310	3296	5116		
90	218	389	609	1000	1558	2558	3649	5664		
100	240	427	668	1097	1708	2805	4002	6212		
110	261	465	727	1194	1859	3053	4356	6760		
120	282	503	786	1290	2010	3300	4709	7308		
130	303	540	845	1387	2160	3548	5062	7856		
140	324	578	904	1484	2311	3795	5415	8404		
150	345	616	963	1581	2462	4043	5768	8952		
160	366	653	1022	1678	2612	4290	6121	9500		
170	388	691	1081	1774	2763	4537	6474	10048		
180	409	729	1140	1871	2914	4785	6827	10596		
190	430	766	1199	1968	3065	5032	7180	11144		
200	451	804	1258	2065	3215	5280	7533	11692		
210	472	842	1317	2161	3366	5527	7886	12240		
220	493	879	1376	2258	3517	5775	8239	12788		
230	514	917	1435	2355	3667	6022	8592	13336		
240	536	955	1494	2452	3818	6270	8945	13884		
250	557	992	1553	2548	3969	6517	9298	14432		
260	578	1030	1612	2645	4119	6765	9652	14980		
270	599	1068	1671	2742	4270	7012	10005	15528		
280	620	1105	1730	2839	4421	7260	10358	16076		
290	641	1143	1789	2935	4572	7507	10711	16624		
300	662	1181	1848	3032	4722	7754	11064	17172		
320	705	1256	1966	3226	5024	8249	11770	18268		
340	747	1332	2083	3419	5325	8744	12476	19364		
360	789	1407	2201	3613	5626	9239	13182	20460		
380	832	1482	2319	3806	5928	9734	13888	21556		
1 SCFM increment		2	4	6	10	15	25	35	55	

¹⁾ at 60°F and 14,7 psia

Coeff. of discharge: 0,860	Orifice							
	D	E	F	G	H	J	K	L
Design area [A ₀]	0,122 in ²	0,217 in ²	0,34 in ²	0,558 in ²	0,869 in ²	1,427 in ²	2,036 in ²	3,16 in ²
Design diameter [d ₀]	0,394 in	0,526 in	0,658 in	0,843 in	1,052 in	1,348 in	1,61 in	2,006 in
Set pressure [psig]								
400	874	1558	2437	4000	6229	10229	14594	22651
420	916	1633	2555	4193	6531	10724	15301	23747
440	958	1708	2673	4387	6832	11219	16007	24843
460	1001	1784	2791	4580	7133	11714	16713	25939
480	1043	1859	2909	4774	7435	12209	17419	27035
500	1085	1934	3027	4967	7736	12704	18125	28131
520	1127	2010	3145	5161	8037	13199	18831	29227
540	1170	2085	3263	5355	8339	13693	19537	30323
560	1212	2161	3381	5548	8640	14188	20243	31419
580	1254	2236	3498	5742	8942	14683	20950	32515
600	1297	2311	3616	5935	9243	15178	21656	33611
650	1402	2500	3911	6419	9997	16415	23421	36351
700	1508	2688	4206	6903	10750	17653	25186	39091
750	1614	2877	4501	7387	11503	18890	26952	41831
800	1719	3065	4796	7870	12257	20127	28717	44571
850	1825	3253	5090	8354	13010	21365	30482	47311
900	1931	3442	5385	8838	13764	22602	32248	50050
950	2036	3630	5680	9322	14517	23839	34013	52790
1000	2142	3819	5975	9806	15271	25076	35778	55530
1200	2565	4572	7154	11741	18285	30026	42840	66490
1400	2988	5326	8333	13676	21299	34975	49901	77449
1600	3410	6080	9512	15611	24312	39924	56962	
1800	3833	6833	10692	17547	27326	44873	64024	
2000	4256	7587	11871	19482	30340	49822	71085	
2200	4679	8340	13050	21417	33354	54771	78146	
2400	5102	9094	14229	23353	36368	59721		
2600	5524	9848	15408	25288	39382	64670		
2800	5947	10601	16588	27223				
3000	6370	11355	17767	29158				
3200	6793	12109	18946	31094				
3400	7215	12862	20125	33029				
3600	7638	13616	21304	34964				
3800	8061	14370	22484					
4000	8484	15123	23663					
5000	10598	18891	29559					
6000	12712	22660						
5 SCFM increment	11	19	29	48	75	124	177	274

¹⁾ at 60°F and 14,7 psia

Coeff. of discharge: 0,860		Orifice					
		M	N	P	Q	R	T
Design area [A ₀]		3,987 in ²	4,807 in ²	7,07 in ²	12,24 in ²	17,72 in ²	29,75 in ²
Design diameter [d ₀]		2,253 in	2,474 in	3,0 in	3,948 in	4,75 in	6,155 in
Set pressure [psig]							
< 30 psig with + 3 psig overpressure	5	on request					
	10	on request					
	No Code Stamp or NB on Nameplates Below 15 psig						
	15	2056	2479	3646	6312	9138	15342
	20	2370	2857	4202	7275	10531	17681
	30	2998	3615	5316	9204	13325	22371
40	3690	4448	6542	11327	16398	27530	
50	4381	5282	7768	13449	19471	32689	
60	5072	6116	8995	15572	22544	37848	
70	5764	6949	10221	17694	25616	43007	
80	6455	7783	11447	19817	28689	48166	
90	7146	8616	12673	21939	31762	53325	
100	7838	9450	13899	24062	34835	58484	
110	8529	10283	15125	26185	37908	63643	
120	9221	11117	16351	28307	40981	68802	
130	9912	11951	17577	30430	44053	73961	
140	10603	12784	18803	32552	47126	79120	
150	11295	13618	20029	34675	50199	84279	
160	11986	14451	21255	36797	53272	89438	
170	12678	15285	22481	38920	56345	94597	
180	13369	16119	23707	41042	59418	99756	
190	14060	16952	24933	43165	62491	104915	
200	14752	17786	26159	45288	65563	110074	
210	15443	18619	27385	47410	68636	115233	
220	16135	19453	28611	49533	71709	120392	
230	16826	20286	29837	51655	74782	125551	
240	17517	21120	31063	53778	77855	130710	
250	18209	21954	32289	55900	80928	135869	
260	18900	22787	33515	58023	84000	141028	
270	19591	23621	34741	60145	87073	146187	
280	20283	24454	35967	62268	90146	151346	
290	20974	25288	37193	64391	93219	156505	
300	21666	26122	38419	66513	96292	161664	
320	23048	27789	40871	70758			
340	24431	29456	43323	75003			
360	25814	31123	45775	79248			
380	27197	32790	48227	83494			
1 SCFM increment		69	83	123	212	307	515

¹⁾ at 60°F and 14,7 psia

Coeff. of discharge: 0,860	Orifice					
	M	N	P	Q	R	T
Design area [A ₀]	3,987 in ²	4,807 in ²	7,07 in ²	12,24 in ²	17,72 in ²	29,75 in ²
Design diameter [d ₀]	2,253 in	2,474 in	3,0 in	3,948 in	4,75 in	6,155 in
Set pressure [psig]						
400	28580	34457	50679	87739		
420	29962	36125	53131	91984		
440	31345	37792	55583	96229		
460	32728	39459	58035	100474		
480	34111	41126	60487	104719		
500	35493	42793	62939	108964		
520	36876	44461	65391	113209		
540	38259	46128	67843	117454		
560	39642	47795	70295	121700		
580	41025	49462	72747	125945		
600	42407	51129	75199	130190		
620	43790	52796	77651			
640	45173	54464	80104			
660	46556	56131	82556			
680	47939	57798	85008			
700	49321	59465	87460			
720	50704	61132	89912			
740	52087	62799	92364			
760	53470	64467	94816			
780	54852	66134	97268			
800	56235	67801	99720			
820	57618	69468	102172			
840	59001	71135	104624			
860	60384	72803	107076			
880	61766	74470	109528			
900	63149	76137	111980			
920	64532	77804	114432			
940	65915	79471	116884			
960	67297	81138	119336			
980	68680	82806	121788			
1000	70063	84473	124240			
1050	73520					
1100	76977					
1150						
1200						
5 SCFM increment	346	417	613	1061		

¹⁾ at 60°F and 14,7 psia

Coeff. of discharge: 0,860		Orifice								
		D	E	F	G	H	J	K	L	
Design area [A ₀]		0,122 in ²	0,217 in ²	0,34 in ²	0,558 in ²	0,869 in ²	1,427 in ²	2,036 in ²	3,16 in ²	
Design diameter [d ₀]		0,394 in	0,526 in	0,658 in	0,843 in	1,052 in	1,348 in	1,61 in	2,006 in	
Set pressure [psig]										
< 30 psig with + 3 psig overpressure	5	on request								
	10	on request								
	No Code Stamp or NB on Nameplates Below 15 psig									
	15	177	315	492	808	1259	2067	2949	4577	
	20	204	363	568	932	1451	2383	3400	5276	
	30	258	459	718	1179	1836	3015	4301	6676	
40	317	565	884	1451	2259	3710	5293	8215		
50	376	671	1050	1723	2683	4405	6285	9755		
60	436	777	1215	1994	3106	5100	7277	11294		
70	495	883	1381	2266	3529	5796	8269	12834		
80	554	988	1547	2538	3953	6491	9261	14374		
90	614	1094	1712	2810	4376	7186	10253	15913		
100	673	1200	1878	3082	4799	7881	11245	17453		
110	733	1306	2043	3354	5223	8576	12237	18992		
120	792	1412	2209	3626	5646	9272	13229	20532		
130	851	1518	2375	3897	6070	9967	14221	22071		
140	911	1624	2540	4169	6493	10662	15212	23611		
150	970	1729	2706	4441	6916	11357	16204	25150		
160	1030	1835	2872	4713	7340	12053	17196	26690		
170	1089	1941	3037	4985	7763	12748	18188	28229		
180	1148	2047	3203	5257	8186	13443	19180	29769		
190	1208	2153	3369	5528	8610	14138	20172	31308		
200	1267	2259	3534	5800	9033	14833	21164	32848		
210	1327	2365	3700	6072	9457	15529	22156	34387		
220	1386	2471	3866	6344	9880	16224	23148	35927		
230	1445	2576	4031	6616	10303	16919	24140	37466		
240	1505	2682	4197	6888	10727	17614	25132	39006		
250	1564	2788	4362	7160	11150	18310	26124	40545		
260	1623	2894	4528	7431	11573	19005	27115	42085		
270	1683	3000	4694	7703	11997	19700	28107	43624		
280	1742	3106	4859	7975	12420	20395	29099	45164		
290	1802	3212	5025	8247	12843	21090	30091	46703		
300	1861	3317	5191	8519	13267	21786	31083	48243		
320	1980	3529	5522	9063	14114	23176	33067	51322		
340	2099	3741	5853	9606	14960	24567	35051	54401		
360	2217	3953	6185	10150	15807	25957	37035	57480		
380	2336	4164	6516	10694	16654	27347	39018	60559		
1 lb increment		6	11	17	27	42	70	99	154	

Coeff. of discharge: 0,860	Orifice							
	D	E	F	G	H	J	K	L
Design area [A ₀]	0,122 in ²	0,217 in ²	0,34 in ²	0,558 in ²	0,869 in ²	1,427 in ²	2,036 in ²	3,16 in ²
Design diameter [d ₀]	0,394 in	0,526 in	0,658 in	0,843 in	1,052 in	1,348 in	1,61 in	2,006 in
Set pressure [psig]								
400	2455	4376	6847	11237	17500	28738	41002	63638
420	2574	4588	7178	11781	18347	30128	42986	66717
440	2692	4800	7510	12325	19194	31519	44970	69796
460	2811	5011	7841	12868	20041	32909	46954	72875
480	2930	5223	8172	13412	20887	34300	48938	75954
500	3049	5435	8504	13956	21734	35690	50922	79033
520	3168	5647	8835	14500	22581	37081	52905	82112
540	3286	5858	9166	15043	23428	38471	54889	85191
560	3405	6070	9497	15587	24274	39861	56873	88271
580	3524	6282	9829	16131	25121	41252	58857	91350
600	3643	6493	10160	16674	25968	42642	60841	94429
650	3940	7023	10988	18034	28085	46118	65800	102126
700	4237	7552	11816	19393	30202	49594	70760	109824
750	4533	8081	12645	20752	32318	53071	75719	117521
800	4830	8611	13473	22111	34435	56547	80679	125219
850	5127	9140	14301	23471	36552	60023	85639	132917
900	5424	9669	15129	24830	38669	63499	90598	140614
950	5721	10199	15958	26189	40786	66975	95558	148312
1000	6018	10728	16786	27548	42903	70451	100517	156009
1100	6612	11787	18442	30267	47136	77403	110437	171405
1200	7206	12845	20099	32986	51370	84355	120356	186800
1300	7800	13904	21755	35704	55604	91308	130275	202195
1400	8394	14963	23412	38423	59837	98260	140194	217590
1500	8988	16021	25068	41141	64071	105212	150113	232985
1600	9582	17080	26724	43860	68305	112164	160033	
1700	10175	18139	28381	46578	72538	119116	169952	
1800	10769	19197	30037	49297	76772	126069	179871	
1900	11363	20256	31694	52015	81006	133021	189790	
2000	11957	21315	33350	54734	85239	139973	199709	
2150	12848	22903	35835	58811	91590	150401	214588	
2300	13739	24491	38320	62889	97940	160830		
2450	14630	26079	40804	66967	104291	171258		
2600	15520	27667	43289	71045	110641	181686		
2750	16411	29255	45774	75123	116992			
2900	17302	30843	48258	79200				
5 lb increment	30	53	83	136	212	348	496	770

Coeff. of discharge: 0,860		Orifice					
		M	N	P	Q	R	T
Design area [A ₀]		3,987 in ²	4,807 in ²	7,07 in ²	12,24 in ²	17,72 in ²	29,75 in ²
Design diameter [d ₀]		2,253 in	2,474 in	3,0 in	3,948 in	4,75 in	6,155 in
Set pressure [psig]							
< 30 psig with + 3 psig overpressure	5	on request					
	10	on request					
	No Code Stamp or NB on Nameplates Below 15 psig						
	15	5774	6962	10239	17727	25664	43087
	20	6657	8026	11805	20438	29588	49675
	30	8423	10155	14936	25859	37436	62851
40	10365	12497	18381	31822	46069	77345	
50	12308	14839	21825	37785	54702	91839	
60	14250	17181	25270	43748	63335	106333	
70	16193	19523	28714	49711	71968	120826	
80	18135	21865	32158	55675	80601	135320	
90	20078	24207	35603	61638	89234	149814	
100	22020	26549	39047	67601	97867	164308	
110	23962	28891	42492	73564	106500	178802	
120	25905	31233	45936	79527	115133	193296	
130	27847	33575	49381	85491	123766	207790	
140	29790	35917	52825	91454	132399	222284	
150	31732	38258	56270	97417	141032	236778	
160	33675	40600	59714	103380	149665	251272	
170	35617	42942	63158	109344	158298	265766	
180	37559	45284	66603	115307	166931	280259	
190	39502	47626	70047	121270	175564	294753	
200	41444	49968	73492	127233	184197	309247	
210	43387	52310	76936	133196	192830	323741	
220	45329	54652	80381	139160	201463	338235	
230	47272	56994	83825	145123	210096	352729	
240	49214	59336	87269	151086	218729	367223	
250	51156	61678	90714	157049	227362	381716	
260	53099	64020	94158	163012	235995	396211	
270	55041	66362	97603	168976	244628	410705	
280	56984	68703	101047	174939	253261	425198	
290	58926	71045	104492	180902	261894	439693	
300	60869	73387	107936	186865	270527	454186	
320	64753	78071	114825	198792			
340	68638	82755	121714	210718			
360	72523	87439	128603	222644			
380	76408	92123	135491	234571			
1 lb increment		194	234	344	596	863	1449

Coeff. of discharge: 0,860	Orifice					
	M	N	P	Q	R	T
Design area [A ₀]	3,987 in ²	4,807 in ²	7,07 in ²	12,24 in ²	17,72 in ²	29,75 in ²
Design diameter [d ₀]	2,253 in	2,474 in	3,0 in	3,948 in	4,75 in	6,155 in
Set pressure [psig]						
500	99717	120226	176825	306129		
520	103602	124910	183714	318056		
540	107487	129593	190602	329982		
560	111372	134277	197491	341909		
580	115257	138961	204380	353835		
600	119141	143645	211269	365761		
620	123026	148329	218158			
640	126911	153013	225047			
660	130796	157697	231936			
680	134681	162380	238824			
700	138566	167064	245713			
720	142450	171748	252602			
740	146335	176432	259491			
760	150220	181116	266380			
780	154105	185800	273269			
800	157990	190483	280158			
820	161875	195167	287047			
840	165760	199851	293935			
860	169644	204535	300824			
880	173529	209219	307713			
900	177414	213903	314602			
920	181299	218587	321491			
940	185184	223270	328380			
960	189069	227954	335269			
980	192954	232638	342157			
1000	196838	237322	349046			
1050	206551					
1100	216263					
1150						
1200						
5 lb increment	971	1171	1722	2982		

Coeff. of discharge: 0,724		Orifice							
		D	E	F	G	H	J	K	L
Design area [A ₀]		0,122 in ²	0,217 in ²	0,34 in ²	0,558 in ²	0,869 in ²	1,427 in ²	2,036 in ²	3,16 in ²
Design diameter [d ₀]		0,394 in	0,526 in	0,658 in	0,843 in	1,052 in	1,348 in	1,61 in	2,006 in
Set pressure [psig]									
< 30 psig with + 3 psig overpressure	5	on request							
	10	on request							
	No Code Stamp or NB on Nameplates Below 15 psig								
	15	14	25	40	65	101	167	238	369
	20	16	29	45	74	115	188	269	417
	30	19	34	54	88	137	226	322	499
40	22	40	62	102	159	260	372	577	
50	25	44	69	114	177	291	415	645	
60	27	49	76	125	194	319	455	706	
70	29	52	82	135	210	344	492	763	
80	31	56	88	144	224	368	525	816	
90	33	59	93	153	238	391	557	865	
100	35	63	98	161	251	412	587	912	
110	37	66	103	169	263	432	616	956	
120	39	69	107	176	275	451	644	999	
130	40	71	112	184	286	469	670	1040	
140	42	74	116	191	297	487	695	1079	
150	43	77	120	197	307	504	719	1117	
160	44	79	124	204	317	521	743	1153	
170	46	82	128	210	327	537	766	1189	
180	47	84	132	216	336	552	788	1223	
190	48	86	135	222	346	568	810	1257	
200	50	89	139	228	355	582	831	1289	
210	51	91	142	233	363	597	851	1321	
220	52	93	146	239	372	611	871	1352	
230	53	95	149	244	380	624	891	1383	
240	54	97	152	249	388	638	910	1413	
250	56	99	155	255	396	651	929	1442	
260	57	101	158	260	404	664	947	1470	
270	58	103	161	265	412	677	965	1498	
280	59	105	164	269	420	689	983	1526	
290	60	107	167	274	427	701	1000	1553	
300	61	109	170	279	434	713	1018	1579	
320	63	112	175	288	449	737	1051	1631	
340	65	116	181	297	462	759	1083	1681	
360	67	119	186	305	476	781	1115	1730	
380	69	122	191	314	489	803	1145	1777	

Coeff. of discharge: 0,724	Orifice							
	D	E	F	G	H	J	K	L
Design area [A ₀]	0,122 in ²	0,217 in ²	0,34 in ²	0,558 in ²	0,869 in ²	1,427 in ²	2,036 in ²	3,16 in ²
Design diameter [d ₀]	0,394 in	0,526 in	0,658 in	0,843 in	1,052 in	1,348 in	1,61 in	2,006 in
Set pressure [psig]								
400	70	125	196	322	501	823	1175	1824
420	72	128	201	330	514	844	1204	1869
440	74	132	206	338	526	864	1232	1913
460	75	134	210	345	538	883	1260	1956
480	77	137	215	353	549	902	1287	1998
500	79	140	219	360	561	921	1314	2039
520	80	143	224	367	572	939	1340	2079
540	82	146	228	374	583	957	1365	2119
560	83	148	232	381	593	974	1390	2158
580	85	151	236	388	604	992	1415	2196
600	86	154	240	394	614	1009	1439	2233
650	90	160	250	410	639	1050	1498	2325
700	93	166	260	426	663	1089	1554	2412
750	96	172	269	441	687	1128	1609	2497
800	99	177	277	455	709	1165	1662	2579
850	103	183	286	469	731	1200	1713	2658
900	106	188	294	483	752	1235	1762	2735
950	108	193	302	496	773	1269	1811	2810
1000	111	198	310	509	793	1302	1858	2883
1200	122	217	340	558	869	1426	2035	3159
1400	132	235	367	602	938	1541	2198	3412
1600	141	251	392	644	1003	1647	2350	
1800	149	266	416	683	1064	1747	2492	
2000	157	280	439	720	1121	1841	2627	
2200	165	294	460	755	1176	1931	2755	
2400	172	307	481	789	1228	2017		
2600	179	320	500	821	1279	2100		
2800	186	332	519	852				
3000	193	343	537	882				
3200	199	355	555	911				
3400	205	366	572	939				
3600	211	376	589	966				
3800	217	387	605					
4000	222	397	620					
5000	249	443	694					
6000	272	486						

Coeff. of discharge: 0,724		Orifice					
		M	N	P	Q	R	T
Design area [A ₀]		3,987 in ²	4,807 in ²	7,07 in ²	12,24 in ²	17,72 in ²	29,75 in ²
Design diameter [d ₀]		2,253 in	2,474 in	3,0 in	3,948 in	4,75 in	6,155 in
Set pressure [psig]							
< 30 psig with + 3 psig overpressure	5	on request					
	10	on request					
	No Code Stamp or NB on Nameplates Below 15 psig						
	15	465	561	825	1429	2068	3473
	20	526	634	933	1615	2338	3925
	30	630	760	1117	1934	2800	4702
40	728	877	1290	2234	3234	5429	
50	813	981	1442	2497	3615	6070	
60	891	1074	1580	2736	3960	6649	
70	962	1160	1707	2955	4278	7182	
80	1029	1241	1825	3159	4573	7678	
90	1091	1316	1935	3350	4851	8144	
100	1150	1387	2040	3532	5113	8584	
110	1207	1455	2140	3704	5362	9004	
120	1260	1519	2235	3869	5601	9403	
130	1312	1581	2326	4027	5830	9788	
140	1361	1641	2414	4179	6050	10157	
150	1409	1699	2498	4325	6262	10514	
160	1455	1754	2580	4467	6467	10858	
170	1500	1808	2660	4605	6666	11192	
180	1543	1861	2737	4738	6860	11517	
190	1586	1912	2812	4868	7048	11832	
200	1627	1962	2885	4995	7231	12140	
210	1667	2010	2956	5118	7409	12439	
220	1706	2057	3026	5238	7584	12732	
230	1745	2104	3094	5356	7754	13019	
240	1782	2149	3160	5471	7921	13298	
250	1819	2193	3225	5584	8084	13572	
260	1855	2236	3289	5695	8244	13841	
270	1890	2279	3352	5803	8401	14105	
280	1925	2321	3414	5910	8556	14364	
290	1959	2362	3474	6014	8707	14618	
300	1993	2402	3533	6117	8856	14868	
320	2058	2481	3649	6318			
340	2121	2558	3762	6512			
360	2183	2632	3871	6701			
380	2243	2704	3977	6885			

Coeff. of discharge: 0,724	Orifice					
	M	N	P	Q	R	T
Design area [A ₀]	3,987 in ²	4,807 in ²	7,07 in ²	12,24 in ²	17,72 in ²	29,75 in ²
Design diameter [d ₀]	2,253 in	2,474 in	3,0 in	3,948 in	4,75 in	6,155 in
Set pressure [psig]						
400	2301	2774	4080	7063		
420	2358	2843	4181	7238		
440	2413	2909	4279	7408		
460	2467	2975	4375	7575		
480	2520	3039	4469	7738		
500	2572	3101	4562	7897		
520	2623	3163	4652	8054		
540	2673	3223	4740	8207		
560	2722	3282	4827	8358		
580	2771	3340	4913	8506		
600	2818	3397	4997	8651		
620	2864	3454	5079			
640	2910	3509	5161			
660	2955	3563	5241			
680	3000	3617	5320			
700	3044	3670	5397			
720	3087	3722	5474			
740	3129	3773	5549			
760	3171	3824	5624			
780	3213	3874	5697			
800	3254	3923	5770			
820	3294	3972	5842			
840	3334	4020	5912			
860	3374	4068	5982			
880	3413	4115	6052			
900	3451	4161	6120			
920	3489	4207	6188			
940	3527	4252	6254			
960	3564	4297	6321			
980	3601	4342	6386			
1000	3638	4386	6451			
1050	3728					
1100	3815					
1150						
1200						

Nominal diameter		1" x 2"	1,5" x 2"	1,5" x 3"	2" x 3"	3" x 4"	3" x 6"	4" x 6"	6" x 8"	6" x 10"	8" x 10"	
Standard-flange dimensions												
ØD1	ANSI150	(inch)	4,25	5	5	6	7,5	7,5	9	11	11	13,5
	ANSI300	(inch)	4,88	6,12	6,12	6,5	8,25	8,25	10	12,5	12,5	15
	ANSI600	(inch)	4,88	6,12	6,12	6,5	8,25	8,25	10,75	14	14	16,5
	ANSI900	(inch)	5,88	7	7	8,5	9,5	9,5	11,5	15	15	18,5
	ANSI1500	(inch)	5,88	7	7	8,5	10,5	10,5	12,25	15,5	15,5	19
	ANSI2500	(inch)	6,25	8	8	9,25	12	12	14	19	19	21,75
ØD2	ANSI150	(inch)	6	6	7,5	7,5	9	11	11	13,5	16	16
	ANSI300	(inch)	6,5	6,5	8,25	8,25	10	12,5	12,5	15	17,5	17,5
b1	depending on the Orifice (table see below)											
b2	ANSI150	(inch)	0,75	0,75	0,88	0,88	0,88	0,94	0,94	1,06	1,12	1,12
	ANSI300	(inch)	0,88	0,88	1,12	1,12	1,25	1,44	1,44	1,62	1,88	1,88

Orifice		D	E	F	G	H	J	K	L	M	N	P	Q	R	T	
b1	ANSI150 x ANSI150	(inch)	1,2	1,2	1,3	1,3	1,3	1,3	1,4	1,4	1,6	1,6	1,6	1,8	1,8	1,9
	ANSI300L x ANSI150	(inch)	0,8	0,8	1,5	1,5	1,5	1,6	1,8	1,8	1,9	1,9	1,9	2,3	2,3	2,4
	ANSI300 x ANSI150	(inch)	0,8	0,8	1,5	1,6	1,6	1,9	1,8	2,0	1,9	1,9	1,9	2,3	2,3	2,4
	ANSI600 x ANSI150	(inch)	0,8	0,8	1,5	1,6	1,7	1,9	1,9	2,3	2,3	2,2	2,2	2,7	2,7	2,4
	ANSI900 x ANSI300	(inch)	1,9	1,9	1,9	1,9	--	--	--	--	--	--	--	--	--	--
	ANSI900 x ANSI150	(inch)	--	--	--	--	2,2	2,2	2,2	2,4	2,4	2,4	2,4	--	--	--
	ANSI1500 x ANSI300	(inch)	1,9	1,9	1,9	2,3	2,6	2,6	2,6	2,8	--	--	--	--	--	--
	ANSI2500 x ANSI300	(inch)	--	--	--	2,8	--	--	--	--	--	--	--	--	--	--

Flanges acc. to ASME / ANSI B16.5

Nominal diameter	1"	1 1/2"	2"	3"	4"	6"	8"	10"
------------------	----	--------	----	----	----	----	----	-----

Standard-Flangeholes			1"	1 1/2"	2"	3"	4"	6"	8"	10"
ØK	ANSI150	(inch)	3,12	3,88	4,75	6	7,5	9,5	11,75	14,25
n x Ød		(inch)	4 x 0,62	4 x 0,62	4 x 0,75	4 x 0,75	8 x 0,75	8 x 0,88	8 x 0,88	12 x 1
ØK	ANSI300	(inch)	3,5	4,5	5	6,62	7,88	10,62	13	15,25
n x Ød		(inch)	4 x 0,75	4 x 0,88	8 x 0,75	8 x 0,88	8 x 0,88	12 x 0,88	12 x 1	16 x 1,13
ØK	ANSI600	(inch)	3,5	4,5	5	6,62	8,5	11,5	13,75	17
n x Ød		(inch)	4 x 0,75	4 x 0,88	8 x 0,75	8 x 0,88	8 x 1	12 x 1,13	12 x 1,25	16 x 1,38
ØK	ANSI900	(inch)	4	4,88	6,5	7,5	9,25	12,5	15,5	18,5
n x Ød		(inch)	4 x 1	4 x 1,13	8 x 1	8 x 1	8 x 1,25	12 x 1,25	12 x 1,5	16 x 1,5
ØK	ANSI1500	(inch)	4	4,88	6,5	8	9,5	12,5	15,5	19
n x Ød		(inch)	4 x 1	4 x 1,13	8 x 1	8 x 1,25	8 x 1,38	12 x 1,5	12 x 1,75	12 x 2
ØK	ANSI2500	(inch)	4,25	5,75	6,75	9	10,75	14,5	17,25	21,25
n x Ød		(inch)	4 x 1	4 x 1,25	8 x 1,13	8 x 1,38	8 x 1,63	8 x 2,13	12 x 2,13	12 x 2,63

	ARI-REYCO R Series Fig. 971-974
ASME Code Section VIII-Division 1 (UV-stamp, NB-stamp) USA	X
Canada Registration - CRN (only version with UV-stamp)	X
Pressure equipment directive PED 97/23/EG Module B+D, H1	X
Seat tightness API 527	X

Soft sealing disc: WEDI

Aflas	-20 °F to +500 °F
BUNA-N	-65 °F to +275 °F
Chemraz	-20 °F to +450 °F
EPR	-65 °F to +325 °F
Fluoraz	-20 °F to +500 °F
Kalrez®	-20 °F to +550 °F
Silicone	-150 °F to +450 °F
Viton®	-65 °F to +400 °F

Parts

Pos.	Description	
74	Retaining plate	SA479Gr.316L
75	O-ring	refer to material list above
77	Retaining screw	SA479Gr.304

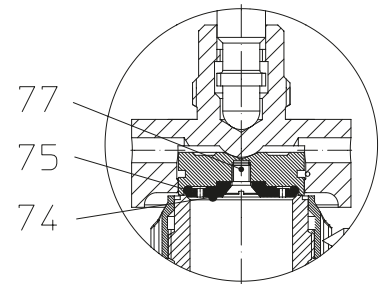
Soft sealing disc WEDI
Parts

Pos.	Description	
55	Bellows	Stainless steel / Inconel assembly
100	Gasket	Klingsil C-4400

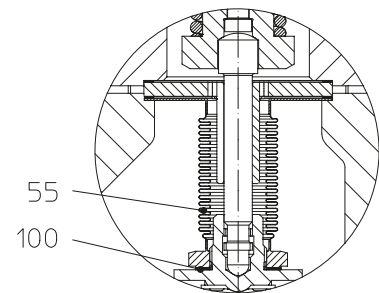
Bellow design (Stainless steel)

Attention: not applicable below 15 psig!

Parts

Pos.	Description	
71	Gasket (gag screw)	Stainless steel
72	Gag screw	SA479Gr.316L

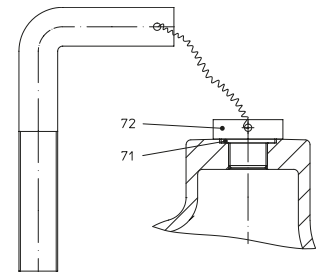

Design for test gag (Stainless steel)
Parts

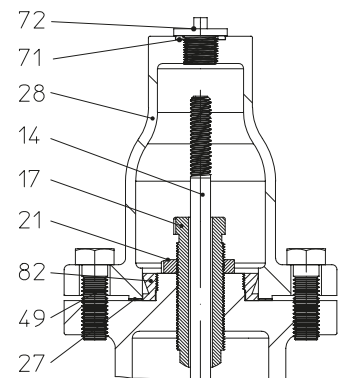
Pos.	Description	
14	Stem	SA479Gr.316L
17	Compression screw	SA479Gr.316L
21	Lock nut	SA479Gr.316L
27	Gasket (cap)	Stainless steel
28	Cap	SA216WCC
49	Bolt	SA193-B7
71	Gasket (gag screw)	Stainless steel
72	Gag screw	SA479Gr.316L
82	Adapter	SA108Gr.1018

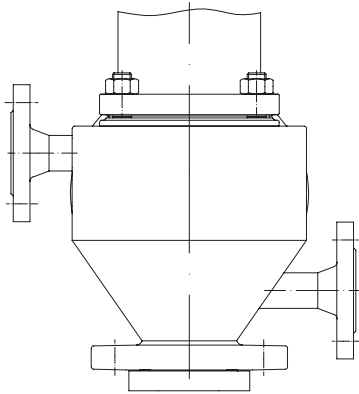

Bolted cap

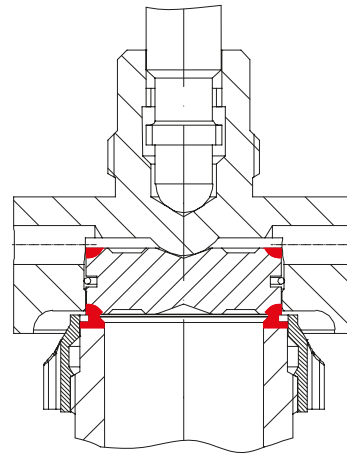

Heating jacket

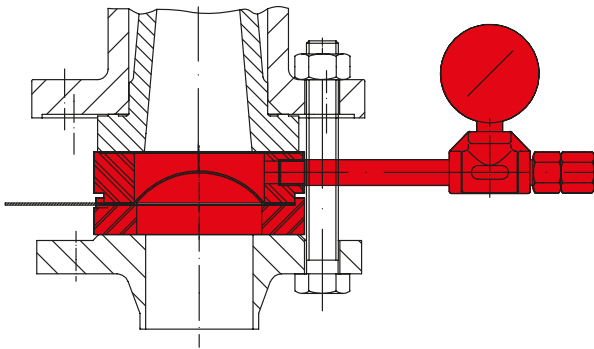

Seat SA479Gr.316Ti / Stellite No. 21
Disc SA479Gr.316Ti / Stellite No. 6



Rupture disc